

FPS System

Fence Protection System

FPS-5 Installation & Operation Guide

G2DA0402-001, Rev A
First edition
September 15, 2009



Senstar Corporation

119 John Cavanaugh Drive
Carp, Ontario
Canada K0A 1L0
Tel: +1 (613)-839-5572
Fax: +1 (613)-839-5830
Website: www.senstar.com
Email address: info@senstar.com

G2DA0402-001, Rev A

First edition

September 15, 2009

Senstar is a registered trademark, and the Senstar logo is a trademark of Senstar Corporation. Product names and Company names used in this document are included for identification purposes only, and are the property of, and may be trademarks of, their respective owners. Copyright © 2009 Senstar Corporation. All rights reserved. Printed in Canada.

The information provided in this guide has been prepared by Senstar Corporation to the best of its ability. Senstar Corporation is not responsible for any damage or accidents that may occur due to errors or omissions in this guide. Senstar Corporation is not liable for any damages, or incidental consequences, arising from the use of, or the inability to use, the software and equipment described in this guide. Senstar Corporation is not responsible for any damage or accidents that may occur due to information about items of equipment or components manufactured by other companies. Features and specifications are subject to change without notice. Any changes or modifications to the software or equipment that are not expressly approved by Senstar Corporation void the manufacturer's warranty, and could void the user's authority to operate the equipment.

Senstar's Quality Management System is ISO 9001:2000 registered.



Limited Warranty

- a) The Company warrants that the electronic components of the products manufactured by the Company are free from all manufacturing defects. The Company's warranty does not extend to the performance of the products, which may vary depending on environmental conditions, use and installation practices. The Company's liability under this warranty shall be limited to, at its option, either repairing or replacing the defective components of the products or granting a credit for the products or parts thereof. The Company's liability shall apply only to products which are returned to the factory or authorized repair point, transportation charges prepaid by the Buyer within one (1) year from the shipment date of the product from the Company and which are, after examination, disclosed to Company's satisfaction to be defective due to defects in workmanship and/or materials. This warranty shall not apply to any products which have been installed, repaired or altered by other than personnel certified by the Company, or to products which have been subject to physical or electrical abuse, misuse, or improper storage or to products which have not been used or maintained in compliance with any applicable recommendations of the Company. This warranty does not apply to any parts or components of the products, which are normally consumed in operation, including but not limited to batteries, fuses and light bulbs.
- b) The Company specifically disclaims any and all warranties, expressed or implied, including but not limited to any warranties or merchantability or fitness for a particular purpose. Under no circumstances be it due to a breach of warranty or any other cause arising out of the performance or non-performance of the Product shall the Company be liable to the Buyer for incidental or consequential damages, including but not limited to: lost profits, loss of property due to the freight, plant downtimes, or suits by third parties.

CONTENTS

	PAGE
1 QUICK START	1
2 GENERAL	12
3 THEORY OF OPERATION	13
4 FENCE CONDITIONS	17
5 INSTALLATION	21
6 INITIAL SETUP AND ADJUSTMENT	49
7 SYSTEM START UP AND TESTING	54
8 MAINTENANCE/TROUBLESHOOTING	59

LIST OF FIGURES	PAGE
Figure 1	Typical MXF-5500/FPS System Conn 2
Figure 2	Fence Mounted FPS Processor 3
Figure 3	Cable Tie Installation 4
Figure 4	Transducer Cable Connections 4
Figure 5	FPS 5 Processor Connections 5
Figure 6	MPS Microwave Installation 6
Figure 7	MPS-4100 Receiver Conn to MXF-5500 7
Figure 8	MXF-5500 Power Supply Connections 8
Figure 9	MXF-5500 Loop Connections 9
Figure 9a	Typical Wiring Diagram 10
Figure 10	FPS Alarm Zone Connections 14
Figure 11	FPS Block Diagram 15
Figure 12	Loose Fabric at Fence Posts 17
Figure 13	Loose Fabric at Diagonal Stiffeners 17
Figure 14	Loose Fabric at Wire Stiffeners 18
Figure 15	Dangling Barbed Wire 18
Figure 16	Improperly Secured Brackets 18
Figure 17	Missing Vertical Locking Posts 18
Figure 18	Excessive Play 19
Figure 19	Loose Chain and Lock 19
Figure 20	Roller and Rail Play 19
Figure 21	Signs Not Securely Attached 19
Figure 22	Fence-mounted Processor 22
Figure 23	Processor Remote Mounting 24
Figure 24	Processor Pedestal Mounting 25
Figure 25	Unreeling Cable 26
Figure 26	Cable Tie Installation 27
Figure 27	Transducer Cable Around Fence Post 28
Figure 28	Transducer Cable Service Loop 28
Figure 29	Increasing Transducer Cable Sensitivity 29
Figure 30	Zone Overlap 30
Figure 31	Helisensor Termination 33
Figure 32	Helisensor Installation/Termination to NEMA Enclosure 34
Figure 33	Retrofit Helisensor Termination to Standard FPS Processor 35
Figure 34	Transducer Cable Routing in Condulet 36
Figure 35	Transducer Cable Connection 36

LIST OF FIGURES PAGE

Figure 36	End-of-Line Termination	37
Figure 37	Splice Termination	37
Figure 38	End-of-Line Term w/ 2 Megaohm Resistor	37
Figure 39	EOL Condulet attached to Fence	38
Figure 40	Condulet Splice Attached to Fence	38
Figure 41	Condulet "G" Attached to Fence	38
Figure 42	Transducer Service Kit	40
Figure 43	Transducer Cable Preparation	40
Figure 44	Hinged Gate Installation	41
Figure 45	Telegate Installation	42
Figure 46	Telegate Support Post Location	43
Figure 47	MPS Microwave System	45
Figure 48	Transducer Cable Connection	46
Figure 49	FPS-5 Wiring Connections	47
Figure 50	Processor Adjustments	49
Figure 51	FPS Main Board Jumper Settings	51
Figure 52	FPS-5 Transponder Board	52
Figure 53	FPS-5 Switch Settings	53

LIST OF TABLES

Table 1	Sensor Cable Capacitance	15
---------	--------------------------------	----

FENCE PROTECTION SYSTEMS

1 QUICK START

Qualified technicians may follow these simplified procedures to install and test the typical FPS-5 Fence Protection System, including installation of the MXF-5500, fence protection, and MPS microwave system. Prerequisites for using the quick start procedures are:

- Attendance at one or more Magal-Senstar training class.
- Prior MXF-5500 field installation experience.

Before proceeding, VERIFY that you have a complete site layout showing zone extents, processor locations, and conduit interconnections. If you are not familiar with any of the procedures described in this section, refer to the appropriate manual for more detailed information.

NOTE: If you are installing a G-Line system, please contact the factory for additional instructions.

IMPORTANT PROCEDURES

Throughout the installation it is very important that certain procedures are observed:

Install ground rods and proper grounding at the MXF-5500, all FPS processors, and all microwave locations.

Terminate fiber as shown. Improper terminations will cause system noise and degrade performance.

Installation

Figure 1 shows the typical fiber optic interconnection of components.

- The interconnect fiber should be run in conduit, either underground or along the base of the fence.
- Optical fiber requirement: Multimode, 62.5 um/125um with not more than 3.5 dB loss/km at 850 nm wave length of light.

We recommend breakout style of cable with each fiber individually enclosed in aramid yarn and a 2 mm elastomer jacket.

A typical approved cable is Optical Cable Corp., (800) 622-7711 www.occfiber.com, part numbers: BX02-070D-WLS/900-OFNR for 2 fibers in cable, BX04-080D-WLS/900-OFNR* for 4 fibers in cable
*OFNR signifies indoor and outdoor riser. Use OFNP for indoor and outdoor plenum.

Use ST connectors with 2 mm strain reliefs.

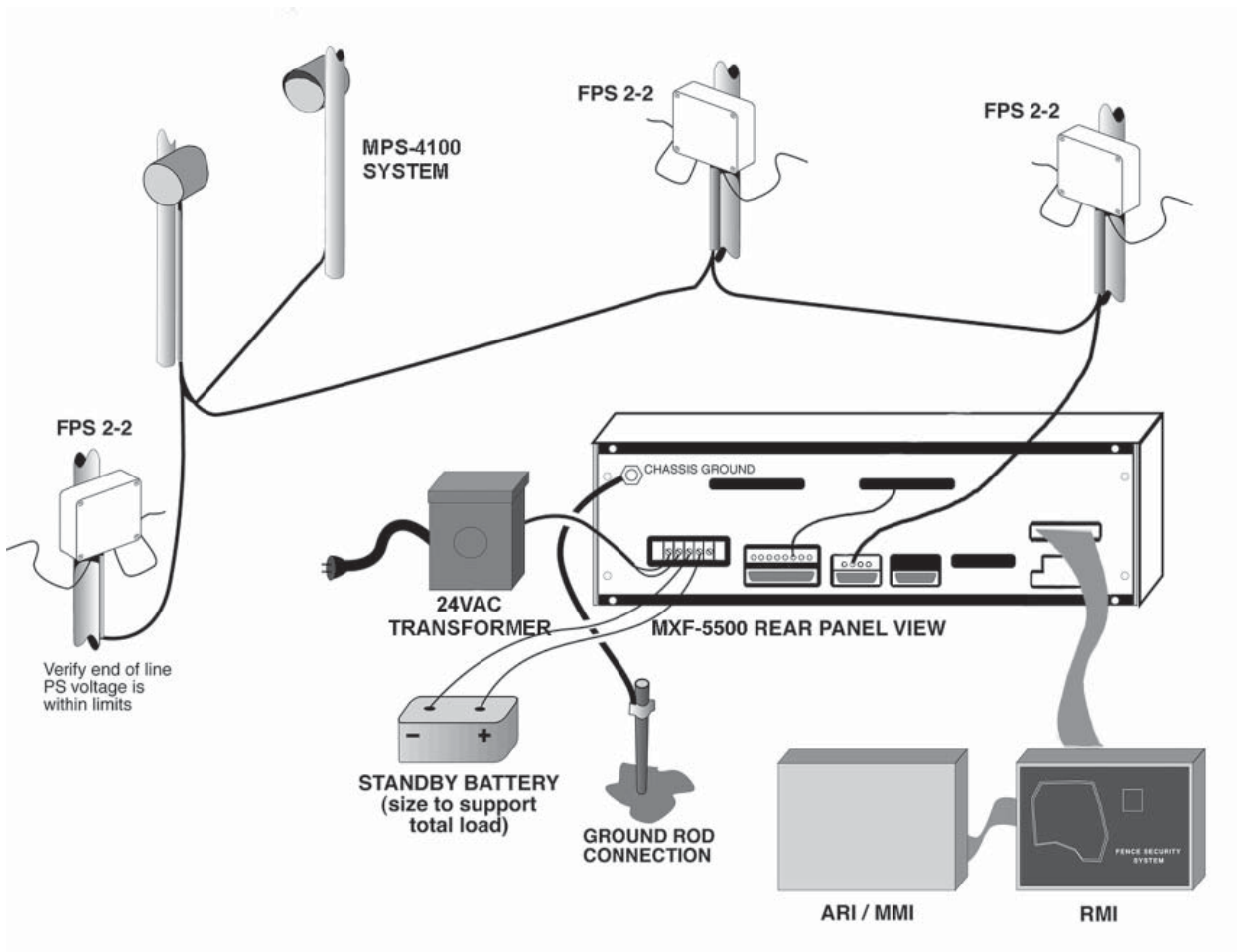

Figure 1. Typical MXF-5500 / FPS System Connections

Mount each FPS processor as shown in Figure 2.

- Use metal brackets or Unistrut-type mounting material to provide a solid backing. A fence post will provide a solid mounting.
- Arrange the conduit/control wiring entrance as shown.
- Install a copper-clad ground rod at each processor location, and connect a minimum 8-gauge ground wire to the processor bolt as shown. **IMPORTANT:** Connect the ground wire directly to the processor bolt as shown.

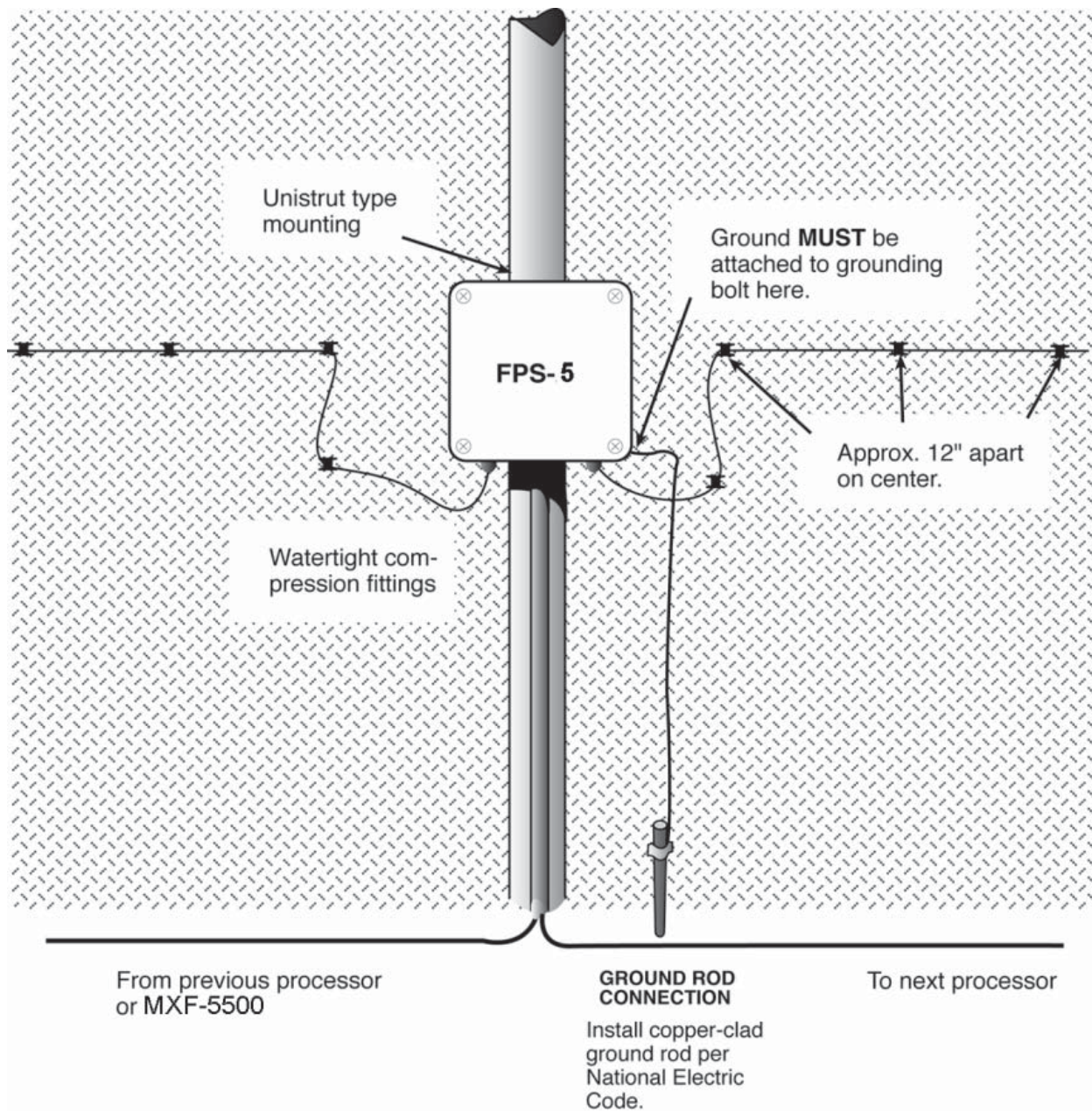

Figure 2. Fence Mounted FPS Processor

Run the sensor cable from each FPS processor as shown in Figures 2 and 3.

NOTE: Your installation may utilize either standard "black" sensor cable or Helisensor. Observe special requirements for each type sensor.

- Attach the sensor cable to the fence at approximate 12-inch intervals with black UV cable ties as shown in Figure 3. Use **ONLY** the approved black UV-protected cable ties.
- Provide service loops every 50 feet and increased sensitivity loops at each corner or end post. Provide cable overlap at adjacent zones. Install TSK termination boxes at each sensor end-of-line and splices if necessary.

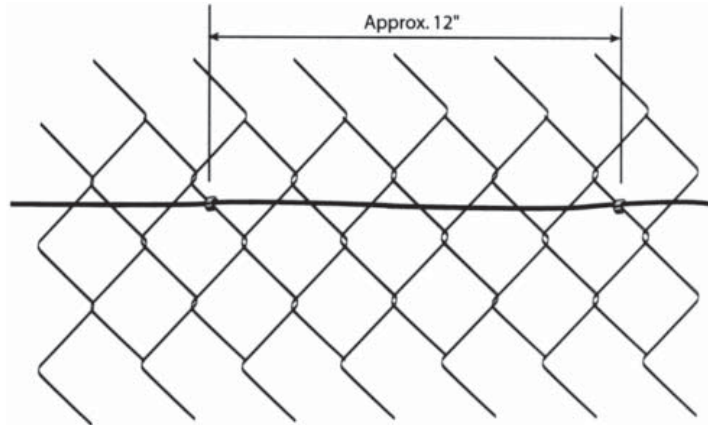
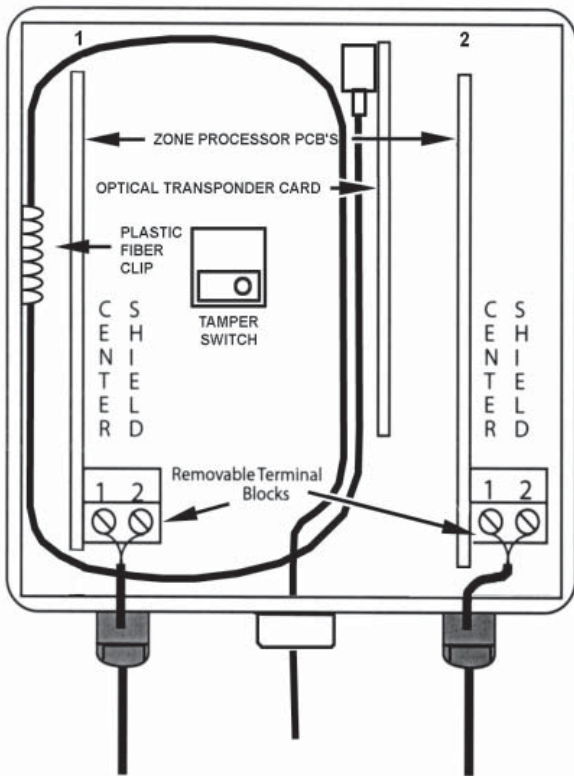

Figure 3. Cable Tie Installation



- Connect each sensor cable to the processor as shown in Figure 4.
- Fibers are routed in large smooth loop. Strip outer jacket back 24" for this loop.

Figure 4. Transducer Cable Connections

Connect the control wiring to each processor as shown in Figure 5.

- Verify that all shields are connected as shown. Keep the shields separate as shown. *DO NOT* connect the individual cable shields to one another.
- Install a short wire jumper between terminals 1 and 3.
- Set the correct transmit and receive address for each processor. Refer to the MXF-5500 manual, Table 5, for processor switch settings.

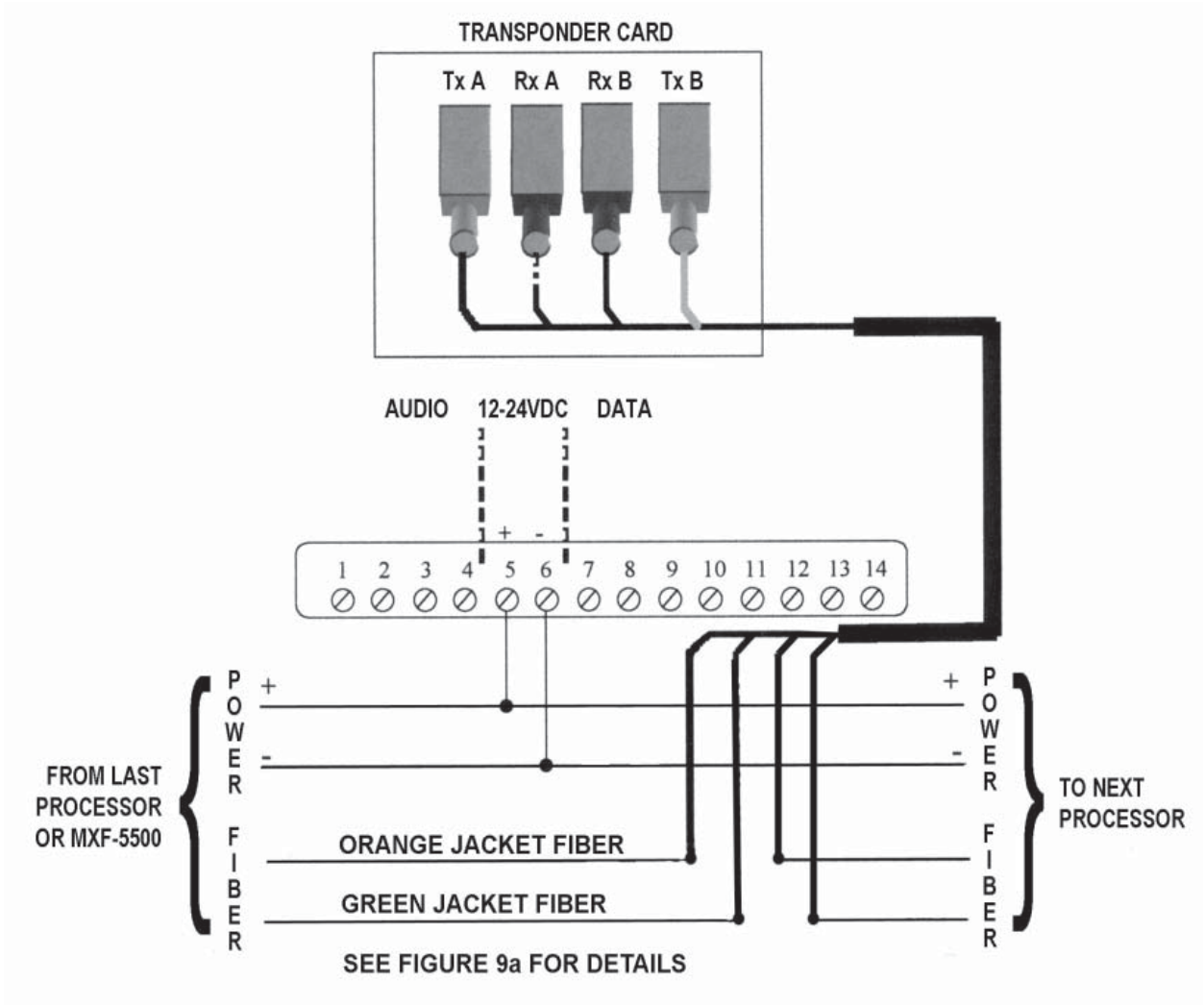

Figure 5. FPS-5 Processor Connections

Mount each MPS microwave unit (pair) as shown in Figure 6. Note that the installation includes the microwave pair and the stand-alone transponder.

- Install each piece of equipment generally as shown.

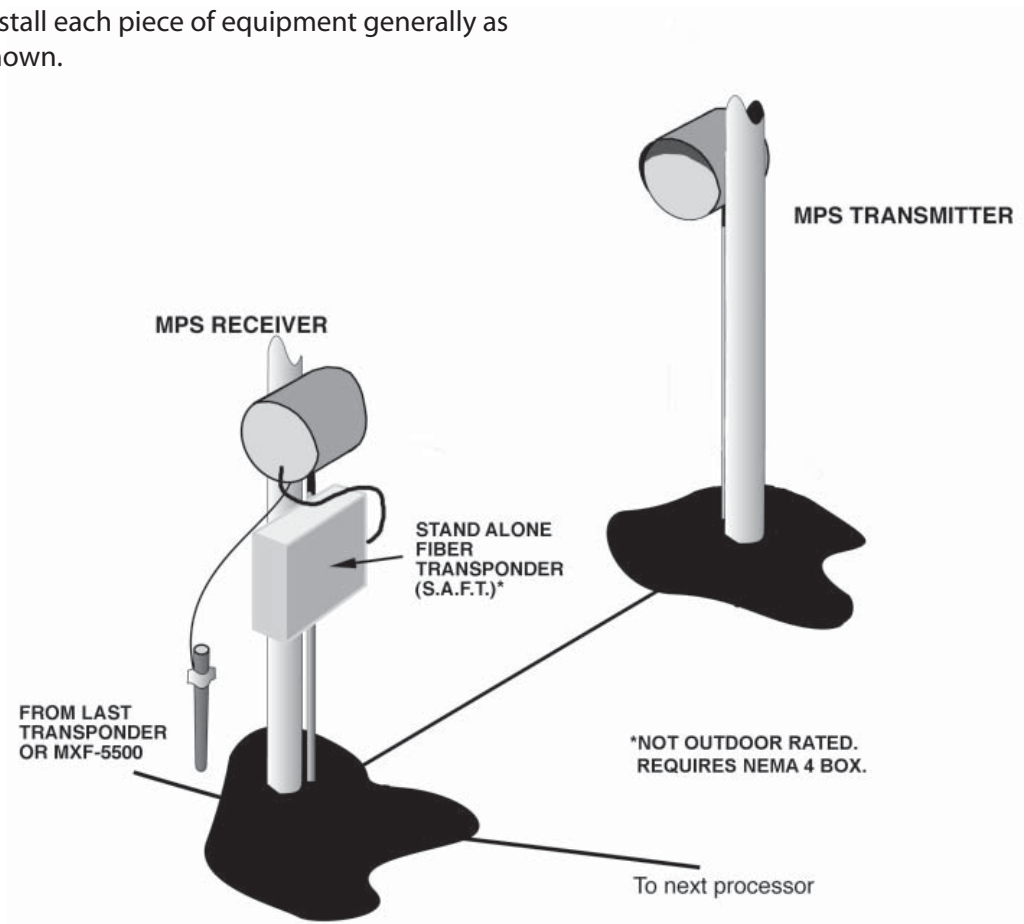

Figure 6. MPS Microwave Installation

- Connect relay wiring as shown in Figure 7.

Position the MXF-5500 Control Unit in the control room as appropriate for proper viewing and operation. Connections will be made to the MXF-5500 rear panel as shown in Figure 1.

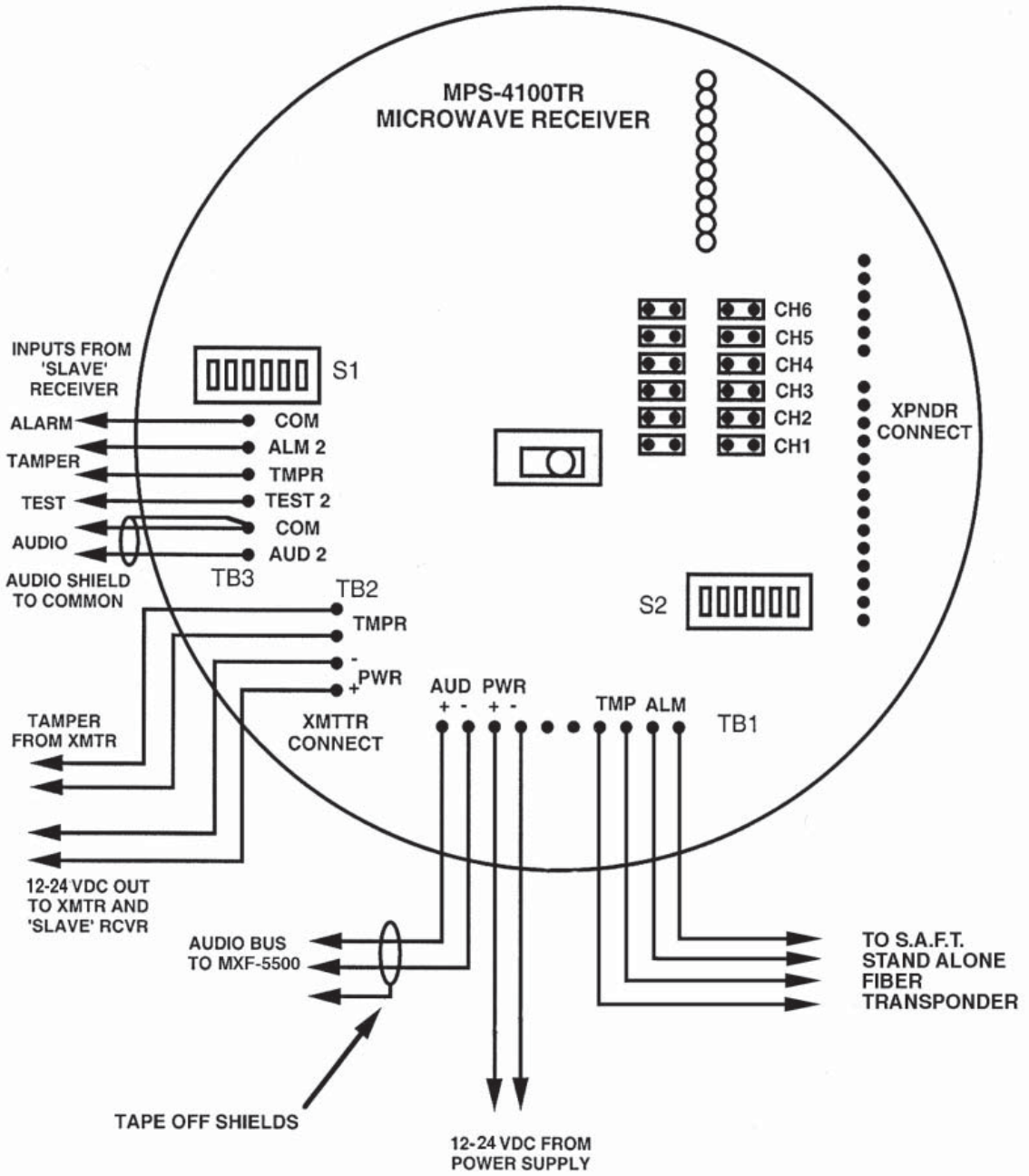

Figure 7. MPS-4100 Receiver Connections to MXF-5500

Connect the power supply transformer and battery as shown in Figure 8.

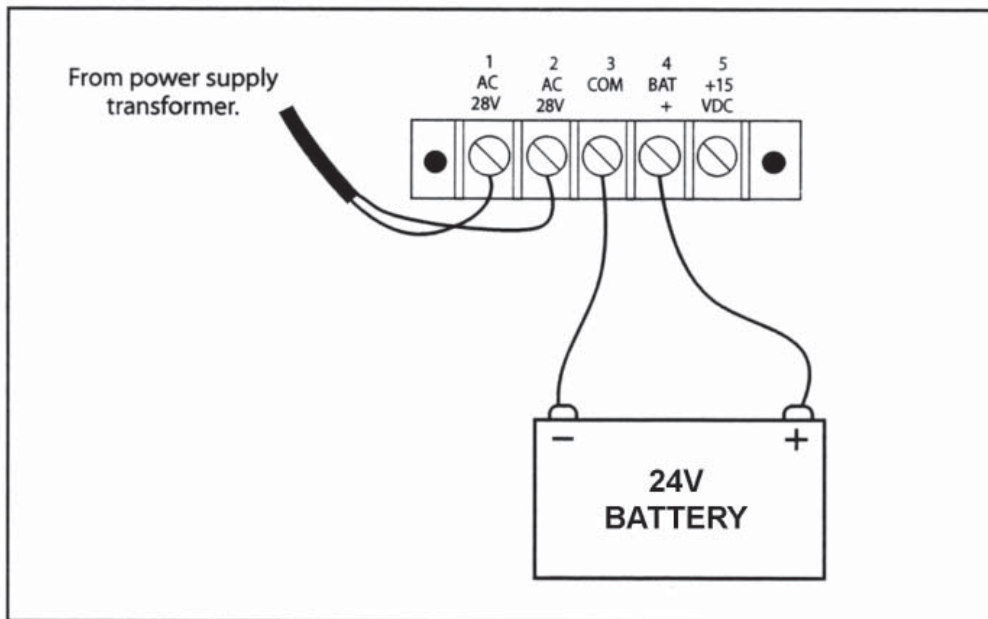

Figure 8. MXF-5500 Power Supply Connections

- Connect the transponder loop cable as shown in Figure 9. Perform the connections for each transponder loop connected to your system.
- Connect the ribbon cable for the Map Interface and Relay/Mobile Map/RANS interface as shown.

Apply power to the MXF-5500 by connecting the AC power first, then the battery system. Perform initial programming to acknowledge initial alarms.

Measure voltage at the end processor. Record voltage and adjust external power supply voltage to bring end-of-loop processor to 12 VDC. Check the voltage at each other processor starting with the unit closest to the MXF-5500. Add resistors at each processor where needed to provide correct processor operating voltage.

Complete MXF-5500 programming by performing the programming steps needed for your system. For programming reference, refer to MXF-5500 Installation Manual, Table 4.

Perform initial testing of each zone, and perform fence quieting procedure if necessary. Adjust the count and gain switches in each processor to provide required climb and cut detection.

Perform final testing, including climb test, in each zone as required by the system specifications.

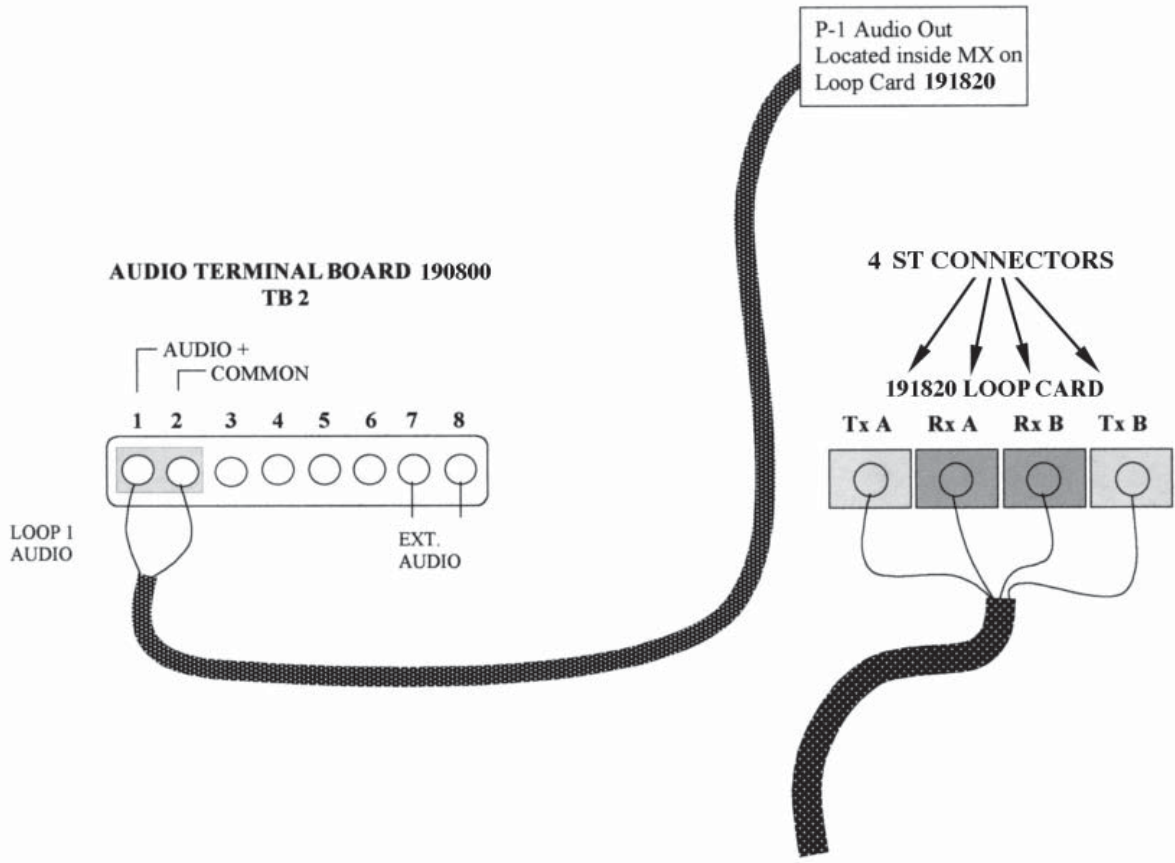

Figure 9. MXF-5500 Loop Connections

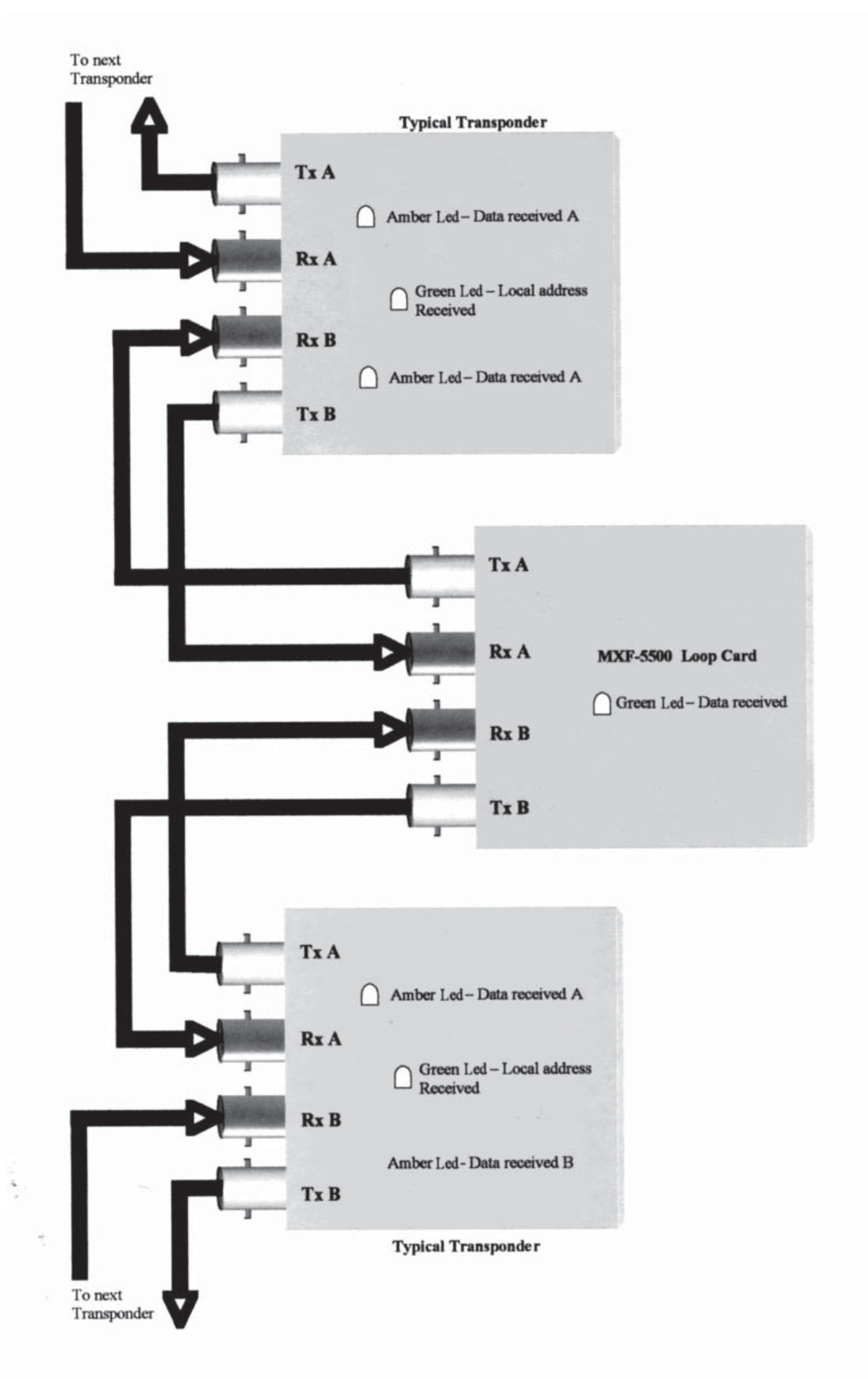

Figure 9a. Sample Wiring Diagram

2 GENERAL

Magal-Senstar manufactures a unique outdoor perimeter intrusion detection system called the Fence Protection System (FPS). The basic FPS system consists of a Fence Mounted Transducer Sensor Cable, and the Signal Processor Unit. The FPS system is designed to be easily installed on chain link fences and will detect someone attempting to climb, lift the fence fabric, or cut through the fence. When the transducer cable is installed on the fence, the transducer cable AND THE FENCE become the fence protection sensor system.

Magal-Senstar FPS systems can be used individually or combined with several FPS units and an alarm control system and accessories, providing the fence protection for the complete facility perimeter.

This manual covers the installation of all of the above listed FPS systems with the exception of the fiber-optic communication system. The differences between units are generally the type of sensor cable utilized, standard or Helisensor, and the type of alarm output type, relay fiber, or MXF-5500 multiplex. During the installation procedures, individual procedures are identified for each type system where required.

3 THEORY OF OPERATION

Concept

When the Transducer Sensor Cable experiences small mechanical shocks or vibrations, an electrical signal is generated between the center conductor and the outer shield. The Signal Processor then analyzes that signal and makes the determination as to whether the vibration is intruder related or from natural causes such as wind, rain, hail, etc. Should there be an intruder, the signal processor will generate an alarm output.

There are two types of alarm processing methods available: Standard and EDAPT. The standard system processes alarm information based on individual settings programmed at each processor. The EDAPT system utilizes a computer modeling program to analyze the fence activity of each alarm zone and automatically adjust the alarm threshold based on current fence conditions and historical data.

Alarm processing

The MSI FPS system is a strain-sensitive cable sensor system, meaning that a mechanical disturbance in the fence causes a small strain on the sensor cable that is converted to an electrical signal.

The sensor cable is a small coaxial cable specially manufactured with a permanent electrical charge throughout its entire length. Any movement in the fence causes a small voltage to appear at the sensor cable output. Magal-Senstar tests every foot of the sensor cable to verify that the alarm sensitivity will be uniform over the entire length.

The sensor cable connects to the FPS processor mounted on or near the fence at the beginning of the detection zone. The mechanical disturbance detected by the sensor cable is sent to the FPS Processor. Each FPS-5 processor contains two independent zones of perimeter protection (see Figure 10). The typical FPS-5 will have up to a 1000-foot alarm zone running in each direction from the processor unit. The standard processor circuitry analyzes the disturbance detected by the sensor cable (see Figure 11). The electronics are designed to match the characteristics of the sensor cable and only report as alarms those signals that are similar to the disturbances caused by climbing, cutting, or lifting the fence fabric.

The EDAPT advanced processor sends alarm data to the MXF-5500 communications and Control System for additional processing. The EDAPT advanced processor MXF-5500 Control System is capable of storing and analyzing each zone's alarm data over time. The alarm data is used in a unique calculation to best determine the occurrence of an actual alarm condition over the external physical forces (wind, rain, etc.), and the aging conditions of the fence installation.

The detected alarm signals are sent by the processor to the alarm monitoring and control point. Alarm monitoring can be accomplished in a number of ways. MSI recommends the MXF-5500 Communication and Control Center, which uses the exclusive CEnDe multiplex alarm communications system, reporting up to 60 alarm zones. The EDAPT system must operate with an EDAPT advanced processor MXF-5500 Control Center and the CEnDe communications system.

The FPS system is capable of monitoring a transducer cable in excess of 1000 feet, depending on the total capacitance of the cable attached to the sensor input. The graph, Table 2, indicates the sensor cable capacitance relative to length. The maximum allowable capacitance is 100,000 pf. In addition to

the transducer cable, it is possible to use nonsensitive cable (30MNS) to connect transducer cable to the processor as long as the maximum capacitance is not exceeded. This is sometimes desirable in cases where the processor is not located near the fence.

The ultimate goal of the fence protection system is reliable detection of cutting and/or climbing with minimum nuisance alarms. Since the FPS sensor system is mounted to the fence fabric, care must be taken when installing and maintaining the fence. A fence installed to normal professional standards will provide an acceptable basis for the FPS system. However, a fence improperly installed and/or missing tie wires and clamps can cause nuisance alarms.

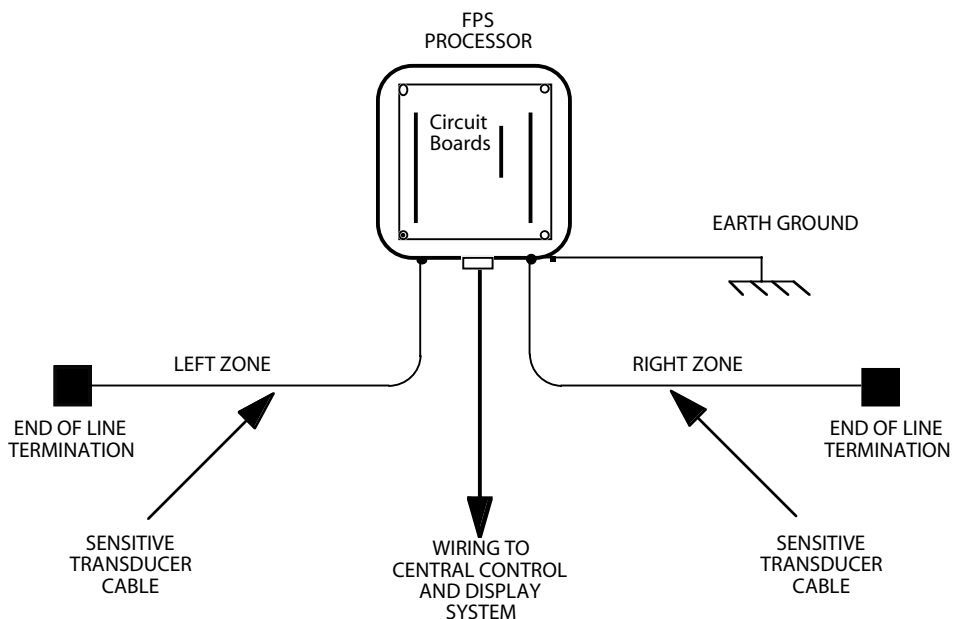

Figure 10. FPS Alarm Zone Connections

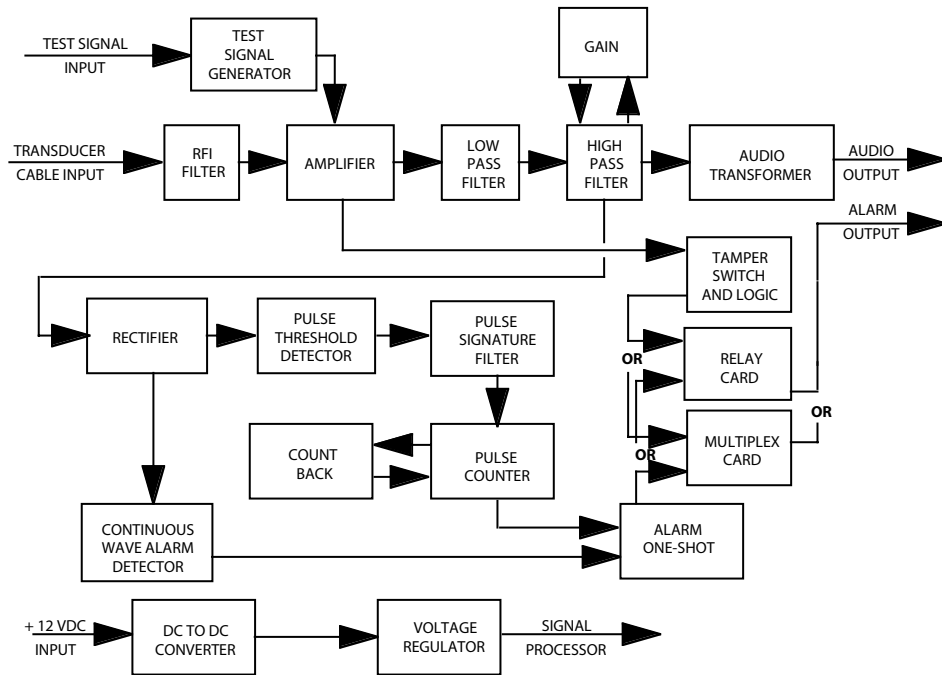

Figure 11. Block Diagram

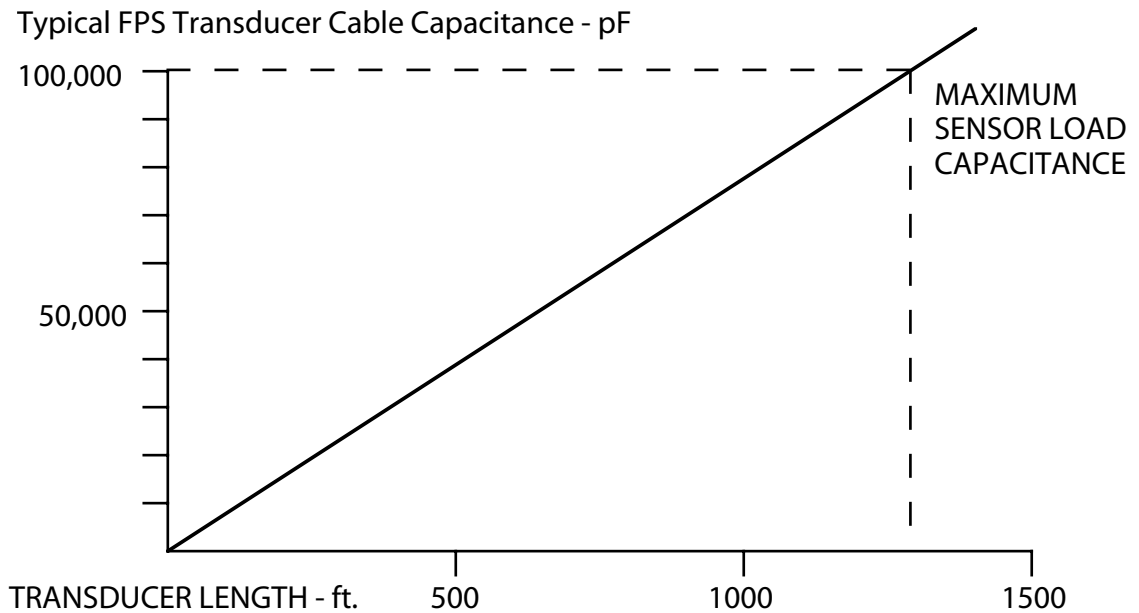

Table 1. Sensor Cable Capacitance

4 FENCE CONDITIONS

Fence Conditions

When the FPS Transducer Sensor Cable is installed on the fence, the sensor cable and the fence become the fence protection system. In effect, the sensor cable listens to the fence to detect the signals caused by climbing, jacking, or cutting the fence.

It is recommended that you walk the entire length of the fence line to determine if the fence requires maintenance prior to installation. Grab the fabric between each and every line post, pull it to you, and let it go. Listen to it! The fence can flex, but if you hear any bangs, clangs, etc., they can be a source of nuisance alarms and should be corrected. Keep a log of any potential problems so they can be identified and repaired before the fence protection system is operational. Refer to Fence Quieting later in this section.

Typical Source or Locations of Trouble Spots

The following photographs (Figures 12 through 21) show examples of the most common problems found with fence installations.



Figure 12 Loose fabric at fence posts or horizontal rails



Figure 13 Loose fabric at diagonal stiffeners



Figure 14 Loose fabric or clamp rings at steel wire stiffeners



Figure 15 Barbed wire dangling due to missing keepers



Figure 16 Mounting pole brackets for barbed wire, concertina or razor ribbon not properly secured to the fence posts



Figure 17 Missing vertical locking posts



Figure 18 Excessive play between locking posts and metal insert



Figure 19 Chain and lock free to vibrate against gate



Figure 20 Too much play between rollers and rails



Figure 21 Signs and/or foreign objects not securely attached to the fence fabric or posts

Additional Sources of Nuisance Alarms

Further inspection may disclose some of the following conditions that may need correcting:

- ▷ Cables, pipes, wires, other fences, limbs, bushes, flagpoles, etc., that may move in the wind and transfer vibrations to the fence.
- ▷ Normal gate operations during protected hours if there is no gate shunt.
- ▷ Condition of the fabric, i.e., old, rusty, loose, rough, and excessive galvanizing material.

NOTE: Spending the time and attention on the fence conditions noted above will result in an efficient and reliable system. Ignoring these sources of nuisance alarms will result in call backs and poor system performance.

Fence Quieting

Section 2 states that once the FPS system is installed on the fence, the FPS and the fence become the alarm system. Therefore, noises generated on the fence can be a major cause of nuisance alarms. However, they do not have to be.

During transducer cable installation, while the work crew is walking the entire length of the perimeter fence, some simple fence quieting action will usually make the operational testing and system check-out go more smoothly.

Major defects in a fence installation will cause fence alarm problems. The major problems should be corrected by a fence contractor. But there are many small problems that can be quickly corrected using your ear, eye, and some black ultraviolet resistant cable ties. Proceed as follows:

- Step 1. Walking the perimeter fence, grab the fence fabric in the center of each fence section. Pull the fence fabric toward you as far as practical and let go.
- Step 2. Listen for noises that sound like metal hitting metal. Typical sounds are clanging, ticking, tapping, etc. The metal-to-metal sounds could be interpreted as counts by the FPS system.
- Step 3. Carefully observe where these noises are coming from. Undoubtedly, a loose piece of metal, a loose fence tie, an improperly tied stiffener, etc., is causing the problem.
- Step 4. Tie the loose item in place using the cable ties. Continue to tie off the noise makers until the fence section is quiet. Continue quieting the fence until all fence panels are quiet.

5 INSTALLATION

General

The installation of the FPS System consists of a systematic installation of FPS processors, transducer cable, special fence protection units, such as gate protection, and connection to the alarm processing system.

In general, the installation should proceed as follows:

- Step 1 Location and installation of processors.
- Step 2 Installation of sensor cable on fence.
- Step 3 Installation of Telegates or other special gate conditions.
- Step 4 Connection to central alarm equipment.
- Step 5 Initial testing and adjustment.
- Step 6 Final Testing.

Processor Mounting

Once the Fence Protection System has been designed, the approximate location of each alarm processor is known. Walking the fence line will allow you to identify the exact location and mounting of each processor unit.

The alarm processors are housed in a moisture proof, EMI and RFI resistant enclosure that may be directly mounted to a fence post. It is important that the processor be mounted with the connectors facing down to prevent moisture penetration. Processor mounting can be slightly different depending on the type of processor being installed. Observe the correct mounting for your installation and the type of processor you are installing.

NOTE: For maximum lightning protection and system noise reduction, the signal processor **MUST** be grounded to a ground rod at the fence, using the 1/4-20 screw located on the signal processor housing. Ground rods should be installed in accordance with the National Electrical Code.

On-Fence Mounting

In most cases, each FPS processor is mounted directly to the non-threat side of the fence. See Figure 22.

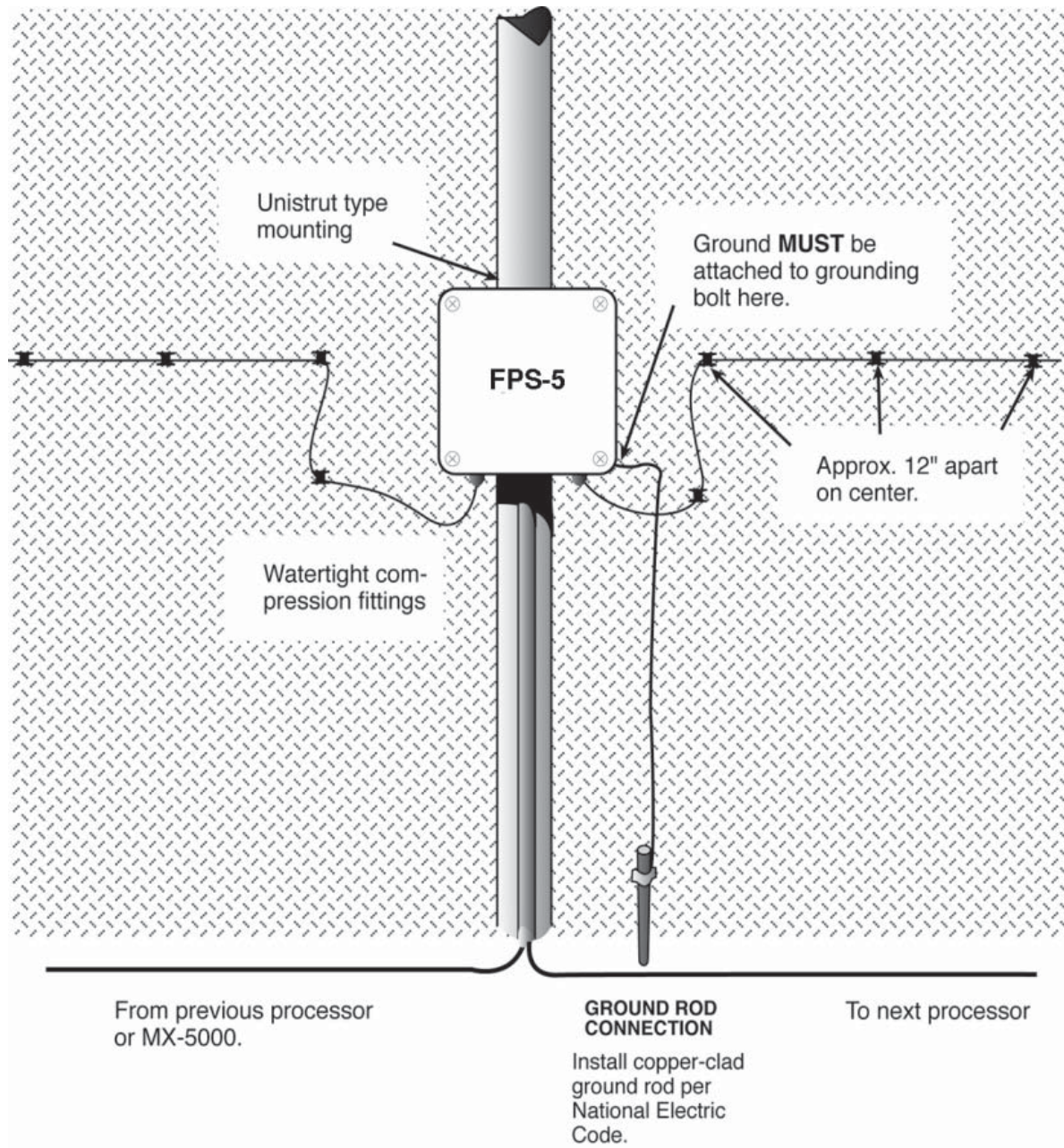

Figure 22. Fence-mounted Processor

When mounting to a fence post, proceed as follows:

- ▷ Fabricate or purchase two pieces of Unistrut or similar type material, for each FPS processor location. The Unistrut should be sufficient length for the processor enclosure or the mounting box as shown. The Unistrut or similar metal should have holes to match the rear mounting holes on the FPS unit.
- ▷ Fabricate or purchase Unistrut or similar pipe clamps to match the size of the fence post where the FPS processor will be mounted. Note that the Unistrut pipe clamps are designed to slide into the Unistrut channel.
- ▷ Assemble the Unistrut pieces into the enclosures before attaching the Unistrut to the fence post. This may best be accomplished in your shop.
- ▷ Mount the alarm processor before extending the signaling conduit to the unit.

If you are installing Helisensor, the processor enclosure will have conduit fittings for the entry of the two sensor cables. Connect the Helisensor directly to the processor enclosure using the conduit fittings provided and then connect each sensor cable to proper terminals as shown later in this manual.

If you are installing Helisensor with a double run of sensor cable, the installation shown in Figure 32 is recommended. This installation using an overall enclosure provides maximum protection since all components are securely enclosed.

Pedestal or Wall Mounting

In certain instances, it is desirable to mount the processors away from the fence line or at some remote location (i.e., inside a building, in an overhead crawl space, etc.). Installing the processors at a remote location can be accomplished using a non-sensitized coaxial cable between the remotely located processor and the fence mounted transducer cable. The nonsensitive cable eliminates nuisance alarms that could be caused by the transducer cable connecting the two locations. The length of nonsensitive cable that can be used is controlled by the total capacitance of the sensor cable and nonsensitive cable as described in the Theory of Operation Section.

Two example installations are shown in Figures 23 and 24. Remote processor operation is not degraded as long as the total combined cable capacitance does not exceed 100,000 pf. Therefore, the processor should be placed within a wiring distance of not more than 100 feet from the fence.

NOTE: For best results, use only the MSI Nonsensitive cable (Part No. 30MNS) between the processor location and the fence mounted sensor cable. Cable with a Teflon dielectric may be microphonic and must not be used.

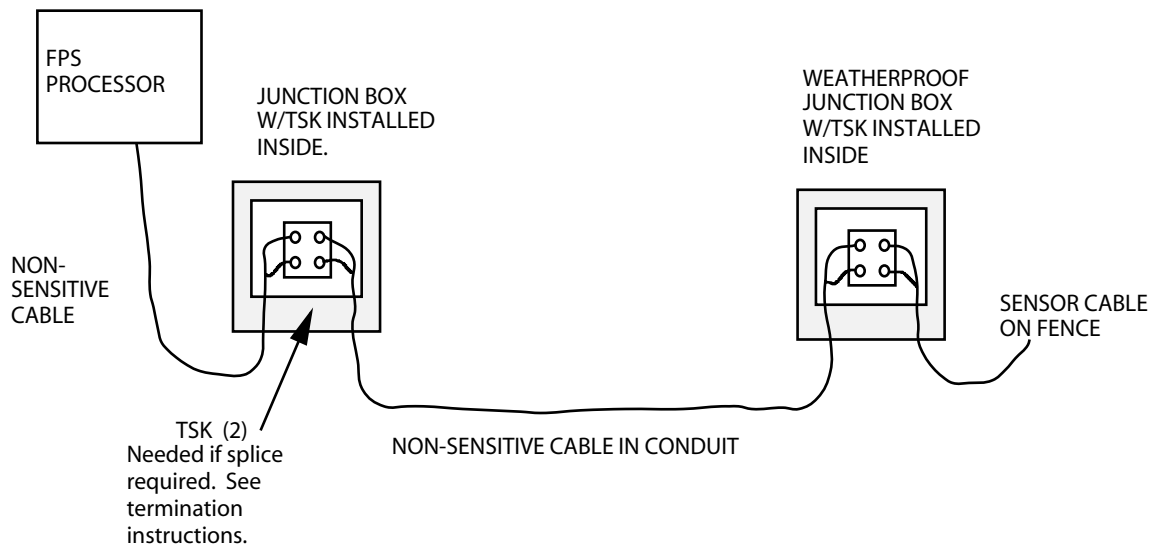
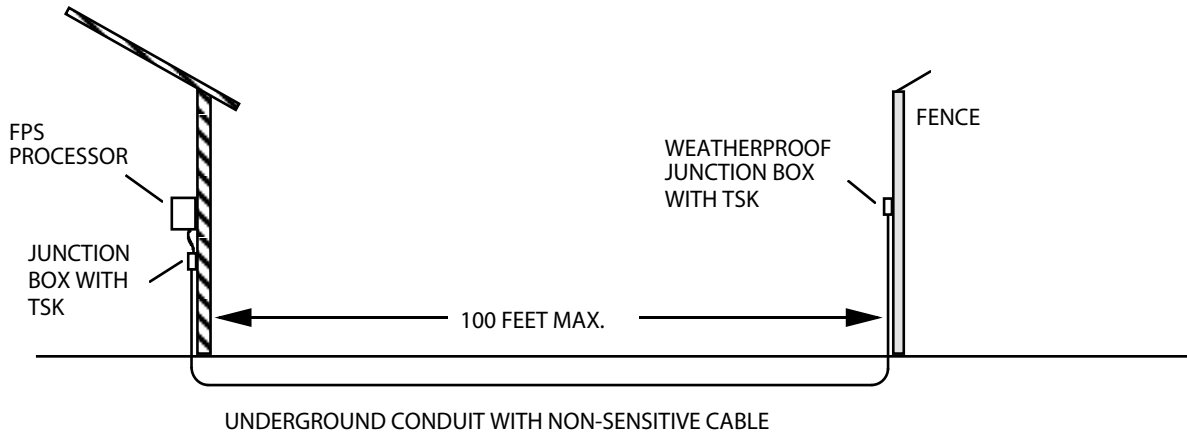

Figure 23. Processor Remote Mounting

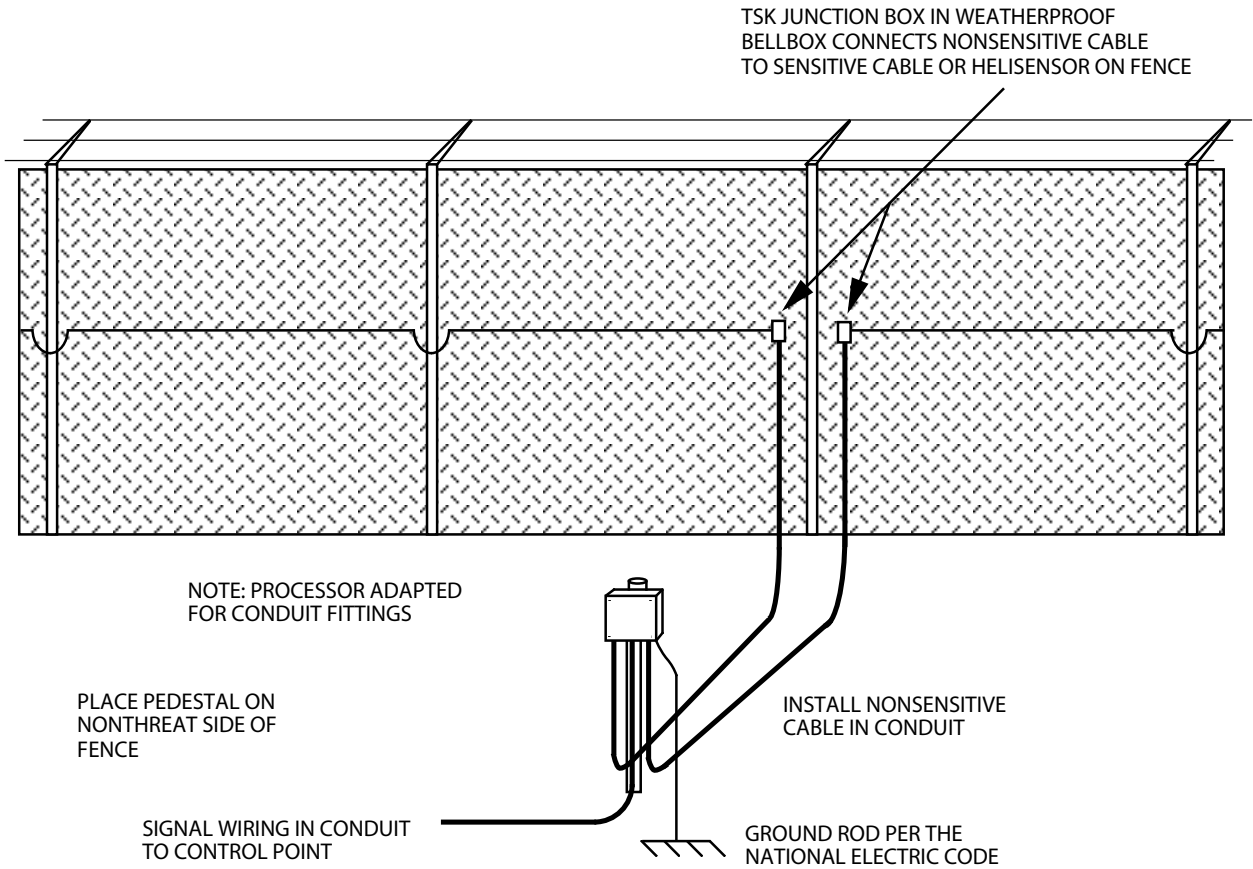

Figure 24. Processor Pedestal Mounting

Transducer Cable Installation

Installation of Standard Coaxial Transducer Cable

Installation of the standard coaxial transducer cable is best accomplished with a minimum of two people; one person to unreel the cable (see Figure 25) while the second person attaches the cable to the fence. If the transducer cable must be installed by only one person, the procedure will be slower. The transducer cable **MUST** be unrolled from the roll so that there are no kinks or spirals when the cable is installed on the fence.



Figure 25. Unreeling Cable

CAUTION: Extreme care should be used when handling the transducer cable as nicking or scraping the outer jacket, and kinking or knotting the cable will shorten the operational life and permit unwanted interference to enter the signal processor.

The transducer cable should be left with enough length at the signal processor for a service loop to be used as a moisture drip leg. See Figure 22. The cable should be attached to the fence in a position 3-6 feet high. This height is chosen to prevent dogs or small animals from damaging the cable and to prevent possible damage by grass fires. Sensitivity is best if the transducer is not installed close to horizontal fence stiffeners.

Cable ties should be located at approximate 12-inch intervals. The transducer cable should be installed taut enough to prevent movement in the wind, and yet not stretched to a point where excessive strain will be placed on the cable as the fence is stressed. This can normally be accomplished by pulling the transducer cable just snug as the plastic cable ties are being installed. See Figure 26.



Figure 26. Cable Tie Installation

When the transducer cable is routed from the fence to pass around a fence post or standard and return again to the fence, be sure to leave a slightly loose, but not drooping, loop. Otherwise, when the fence is stressed, the cable can chafe, wearing through the cable jacket.

Example: You should be able to just push a pencil between the fence post and transducer cable.

See Figure 27. If the fence post or standard has a rough or sharp surface, additional insulation must be installed on the transducer cable to prevent damage from long term abrasion. A damaged jacket will permit moisture penetration and allow undesirable interference into the signal processor. Installation of a spiral wrapped flexible protective material, such as the Panduit 1/8 T12F-0, or similar, is recommended. The protective material must be black weather resistant polyethylene.

Cable ties must not be tightened so tight that the conductor insulation is damaged. To prevent this from occurring, do not use tie wrap Installation tools. Use your hands to draw each tie up until snug.

Care must be taken when installing cable ties to assure the transducer cable is not tied to the fence where sharp metal and/or excess galvanizing material may protrude and damage the cable.

To allow for future transducer cable repair, it is advisable to provide service loops (one foot offsets) approximately every 40 to 50 feet at the fence posts. See Figure 28.

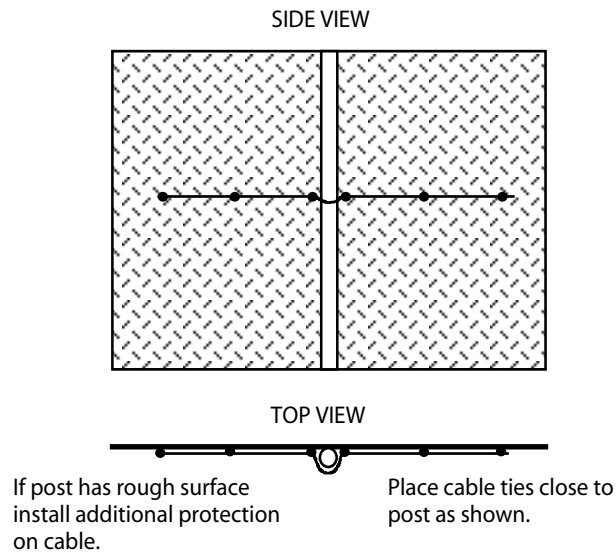

Figure 27. Transducer Cable Around Fence Post

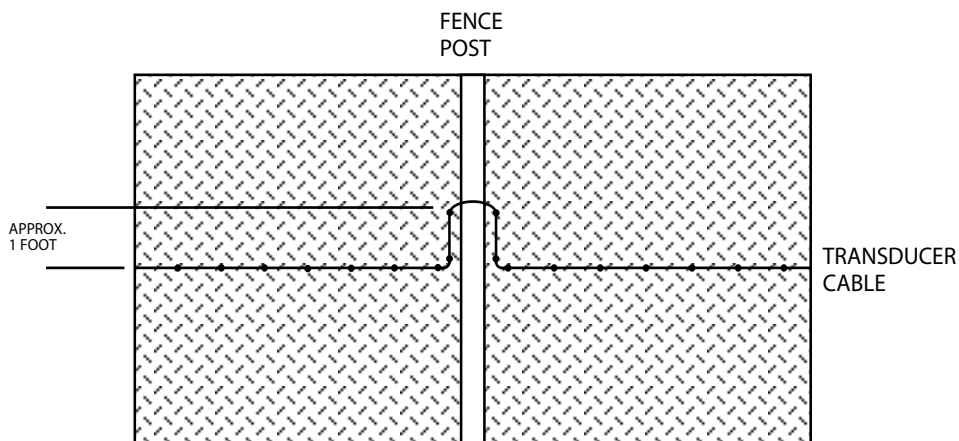

Figure 28. Transducer Cable Service Loop

The fence fabric on either side of a corner post is quite rigid due to both horizontal and diagonal stiffeners. To better ensure detection of a climber, increase the sensitivity by vertically looping the transducer cable several times on either side of the corner post. See Figure 29.

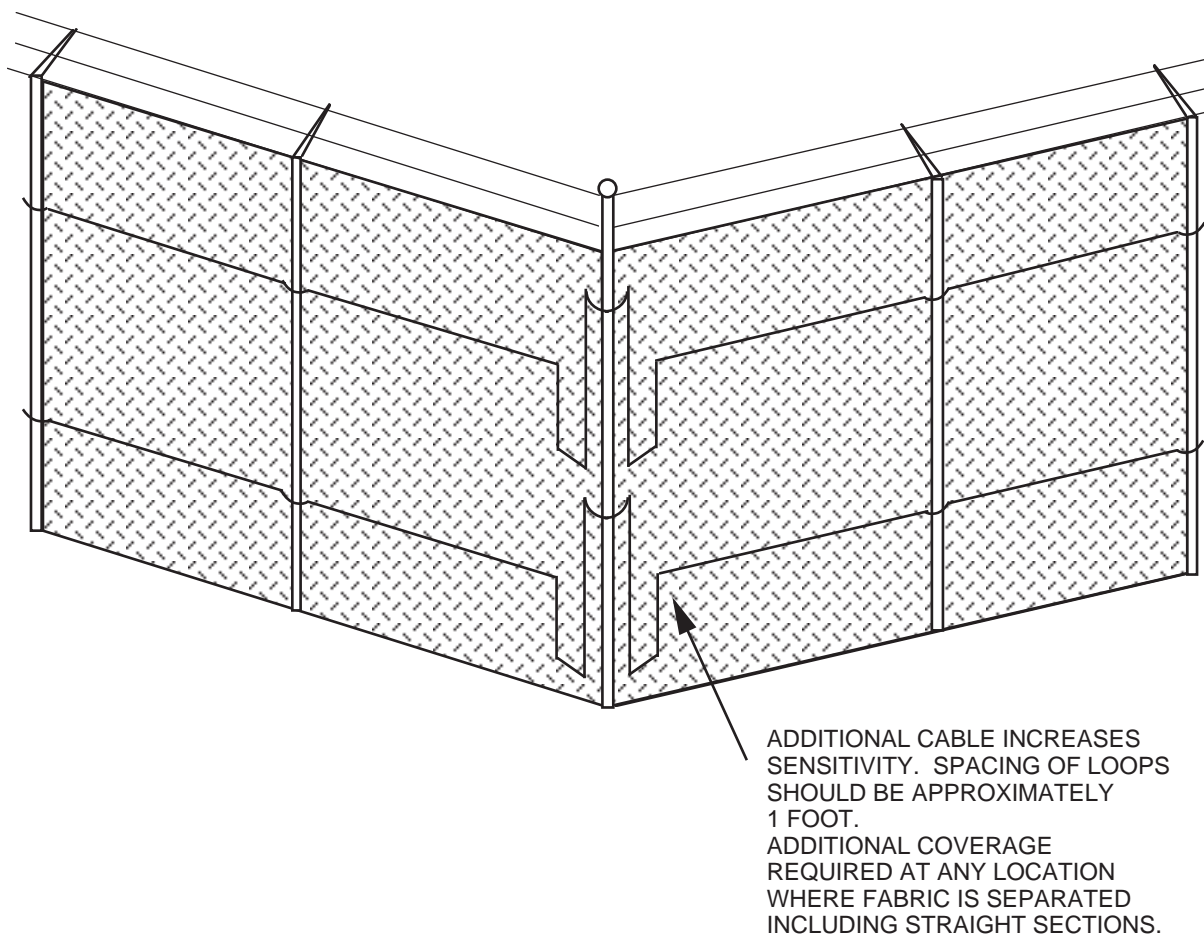

Figure 29. Increasing Transducer Cable Sensitivity

Overlap of adjacent zones is not required but may be desired by some customers. Refer to Figure 30 if overlap is desired. If, at the end of a zone there is an excess of transducer cable, do not coil excess cable as this may become hypersensitive and be the source of nuisance alarms. Cut the cable to the actual length and terminate with the transducer service kit (TSK) and the 1 meg resistor provided. See TSK installation later in this section.

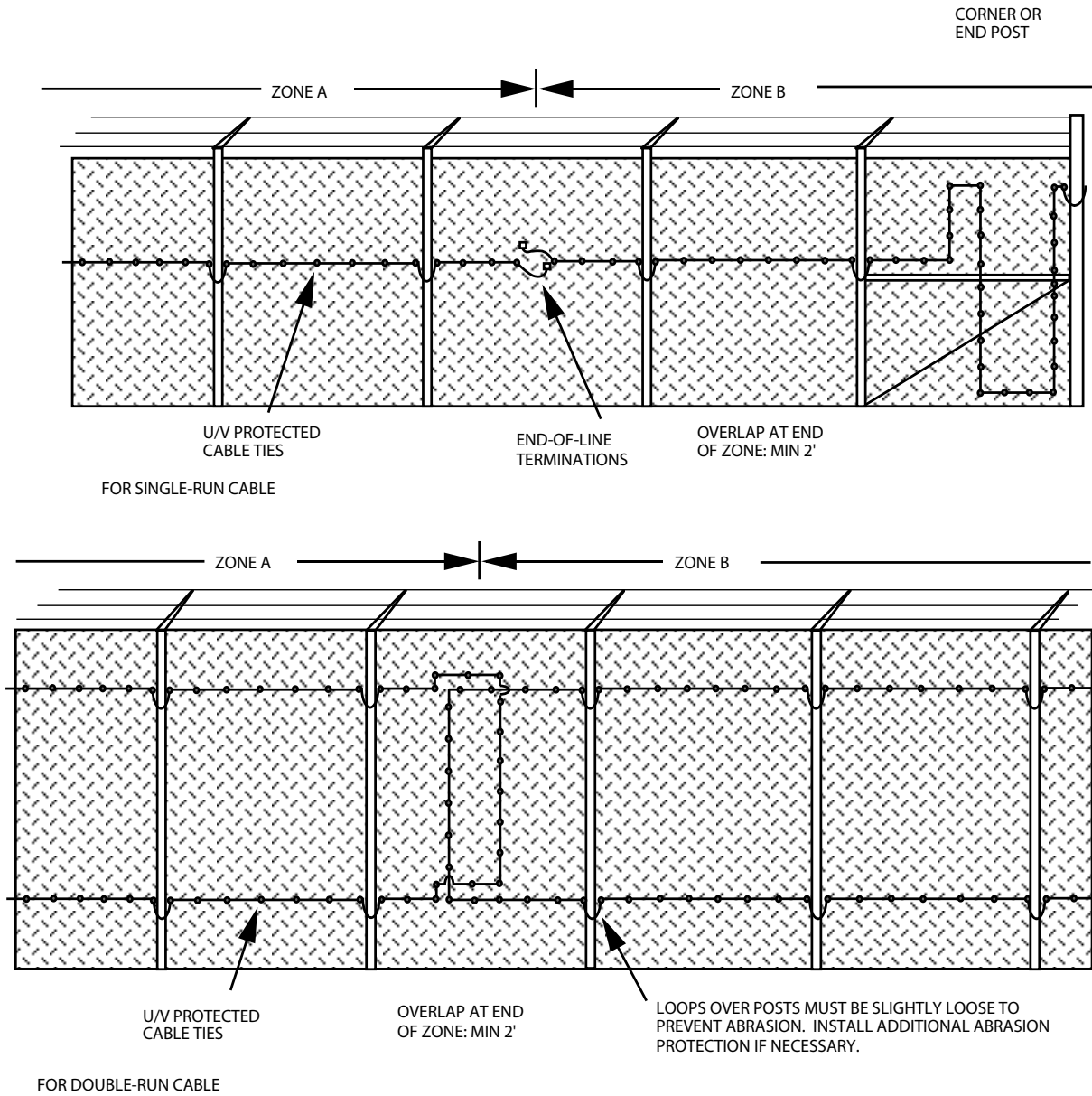

Figure 30. Zone Overlap

Transducer Cable Installation With Two or More Persons

Begin at one end of a zone with one person unrolling the cable and one person loosely tying the cable to the fence. Using cable ties, loosely tie the cable to the fence every 20 to 30 feet to keep it off the ground. Start by leaving a sufficient service loop, then loosely tie the cable at the proper height over the length of the zone. It is best not to cut and terminate the transducer cable until the cable is completely attached to the fence.

Starting at one end of the loosely tied transducer cable (leaving sufficient cable for routing and termination) begin tying the transducer cable to the fence at the approximate 12-inch intervals as shown in Figure 26. Observe special precautions at each post as previously detailed. Continue to the end of the zone and terminate properly. It is recommended that you continue to attach one zone at a time until the entire perimeter is complete.

Transducer Cable Installation With One Person

NOTE: This procedure is not recommended for zones over 100 meters (300 feet) in length.

Start at the beginning of each zone and tie loose (3-inch loop) cable ties at the proper fence height and at intervals of approximately 10 feet. This provides a row of open cable ties that will allow quick threading of the cable to the fence. Place the transducer cable on a suitable cable reel dispenser so the cable will roll directly off the reel with no kinks or knots.

Carefully pull the cable from the reel and thread through the loose ties, one after another, throughout the entire zone length. You must be very careful that the cable does not get caught, scraped or cut. You should periodically check the cable reel and the cable you have pulled through the cable ties. As an alternate to the temporary cable ties for threading the sensor cable, you can make a set of S-hooks from #10 insulated solid wire, such as #10 THHN. The S-hooks should be hung on the fence at 10-15 foot intervals and the sensor cable hung through them. Walk the cable reel along as you place the cable in the hooks. It is recommended that you not string more than 100 feet of sensor cable through the S-hooks at one time.

After threading the cable, begin at one end (leaving sufficient cable for routing and termination) and secure the cable at approximate 12-inch intervals as shown in Figure 26. Observe special precautions at each post as detailed above. Continue to the end of the zone and terminate properly.

Helisensor Transducer Cable Installation

Helisensor transducer cable uses the same FPS fence protection technology, but incorporates a flexible conduit around the coaxial transducer cable to protect from damage or abuse. Helisensor transducer cable is only available in the 100 meter (328 feet) length; however, up to 3 sections can be combined for zone lengths up to 300 meters.

Each length of Helisensor includes a 1/2-inch conduit fitting for attaching to the processor and a conduit with terminations inside. When zone lengths greater than 100 meters are required, the second (or third) length of Helisensor is connected by screwing a 1/2-inch conduit fitting (2nd section) into the conduit (1st section) and terminating the sensor cable to the connector provided in the conduit.

Helisensor can be fastened to the fence fabric using either the conventional ultraviolet resistant plastic cable ties or stainless steel ties. The stainless steel ties can be used where abuse or other damage may result.

NOTE: Do not use ordinary cable ties because they will not withstand the effects of sunlight. MSI provides the proper cable ties with each roll of sensor cable.

The Helisensor installation procedure is very similar to the installation of standard coaxial transducer cable, with added requirements for trimming the zone to size.

Begin by rolling the Helisensor out on the ground alongside the fence. Do not unroll Helisensor in damp or wet areas. Due to the size and weight of the Helisensor cable reels, a suitable cable reel holder is recommended. Lift the Helisensor to the fence and attach at approximate 12-inch intervals using the cable ties furnished. The Helisensor should be pulled straight between the cable ties, but **DO NOT OVERSTRETCH. THE SPIRAL COVERING MUST REMAIN FLEXIBLE OR THE SENSOR WILL NOT FUNCTION PROPERLY.** Allow for extra sensitivity at corner posts (see Figure 29).

In most cases, the zone length will not coincide with the length of the Helisensor so the cable length will have to be adjusted to match the length of the zone. If the zone is longer than 100 meters, connect a second length of Helisensor and continue to the processor end of the zone. If the Helisensor is too long when you reach the processor end, it is best to leave the extra length connected until you have completely tied the Helisensor to the fence at approximate 12-inch intervals. Then cut and terminate the excess Helisensor as detailed below.

The processor end of the Helisensor has a 1/2-inch conduit termination. The FPS-5 enclosure is available with two cable entry configurations. The standard FPS-5 enclosure provides two compression fittings for the sensor cable. The optional configuration, FPS-5 ()H (H suffix for Helisensor) is drilled to accept the Helisensor 1/2-inch conduit terminations in place of the compression fittings. The H configuration allows Helisensor termination directly to the FPS enclosure, as shown in Figure 31, and is recommended for new installations. A double run Helisensor should be terminated to a NEMA style enclosure which contains the Processor as shown in Figure 32. The enclosure completes the full mechanical protection of the sensor cable. When retrofitting Helisensor to an existing standard FPS processor, the Helisensor is terminated to a Condulet "G." The Condulet "G" contains a seal-tight compression gland on one end. Sensitive or nonsensitive cable is then run between the FPS processor and the Condulet "G" and fed through the compression glands at each end. (See Figures 33 and 41.)

NOTE: Always install condulets at a 45 degree angle slightly higher than the Helisensor to form a drip loop and prevent moisture from entering the condulet.

Trim the Helisensor to the required length for termination as follows:

- ▷ With the processor installed, measure and mark the Helisensor metal jacket length to mate with the enclosure. Be sure to leave sufficient Helisensor for a drip loop.
- ▷ Using a flexible conduit cutter or a hacksaw, score and break the Helisensor metal jacket making sure you do not cut the transducer cable inside.
- ▷ Remove the excess Helisensor jacket, leaving enough of the black transducer cable to route

through the termination box and conduit and to the terminations inside the processor enclosure.

- ▷ Terminate the Helisensor to the enclosure as shown in Figures 31 or 32, using the 1/2-inch conduit termination provided. Helisensor should be attached to 1/2-inch conduit fitting before it is secured in the processor enclosure.
- ▷ Terminate the black transducer cable inside the processor as detailed under Transducer Cable Connections.
- ▷ Mount each conduit slightly above the line of Helisensor to create a drip loop to prevent moisture buildup at conduit terminations.
- ▷ For remote-mounted processors, follow instructions in "Processor Mounting (page 27) ... Pedestal or Wall Mounting (page 29) sections (see Figures 23-24) and terminate Helisensor to bell box.

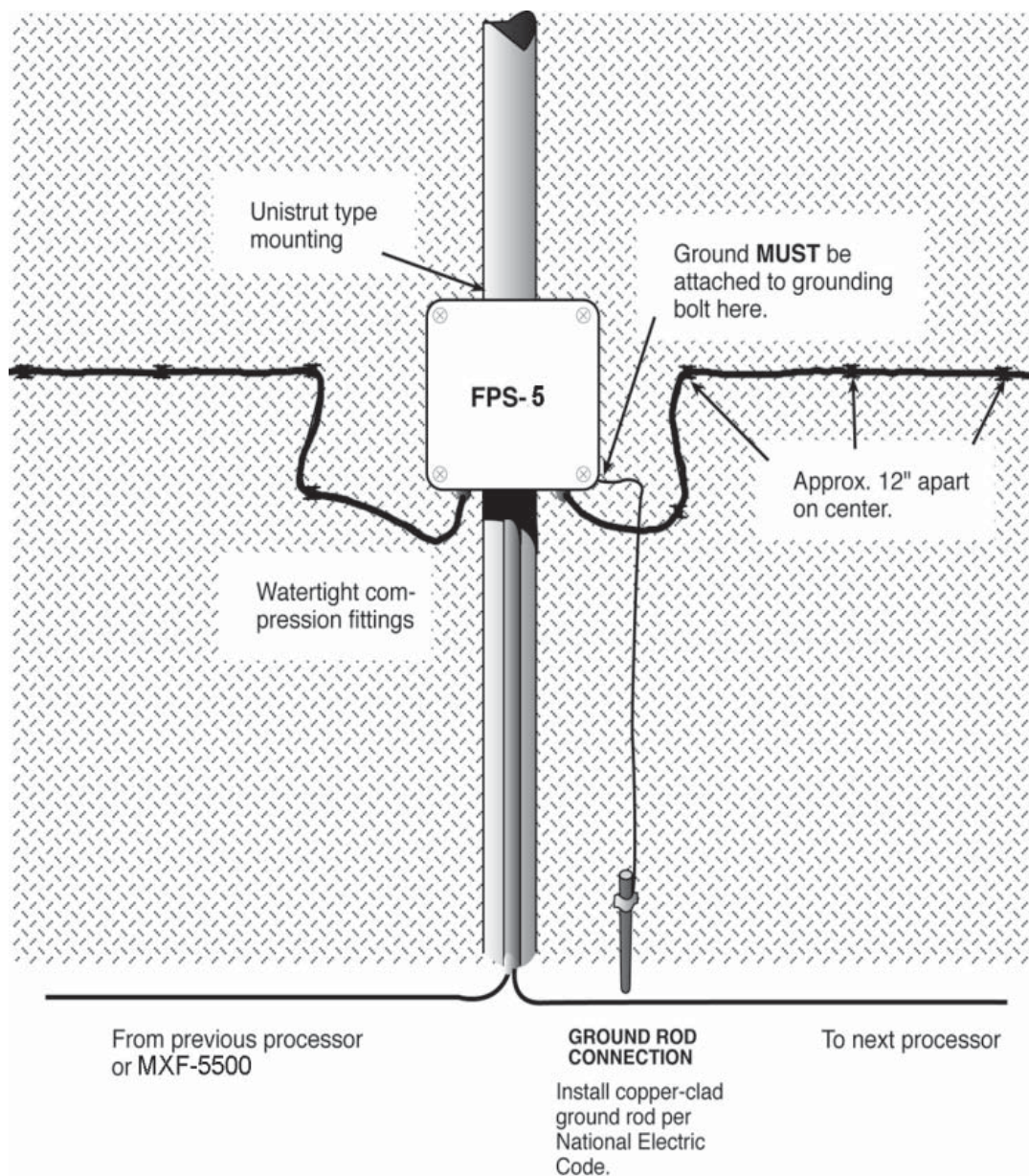

Figure 31. Helisensor Termination

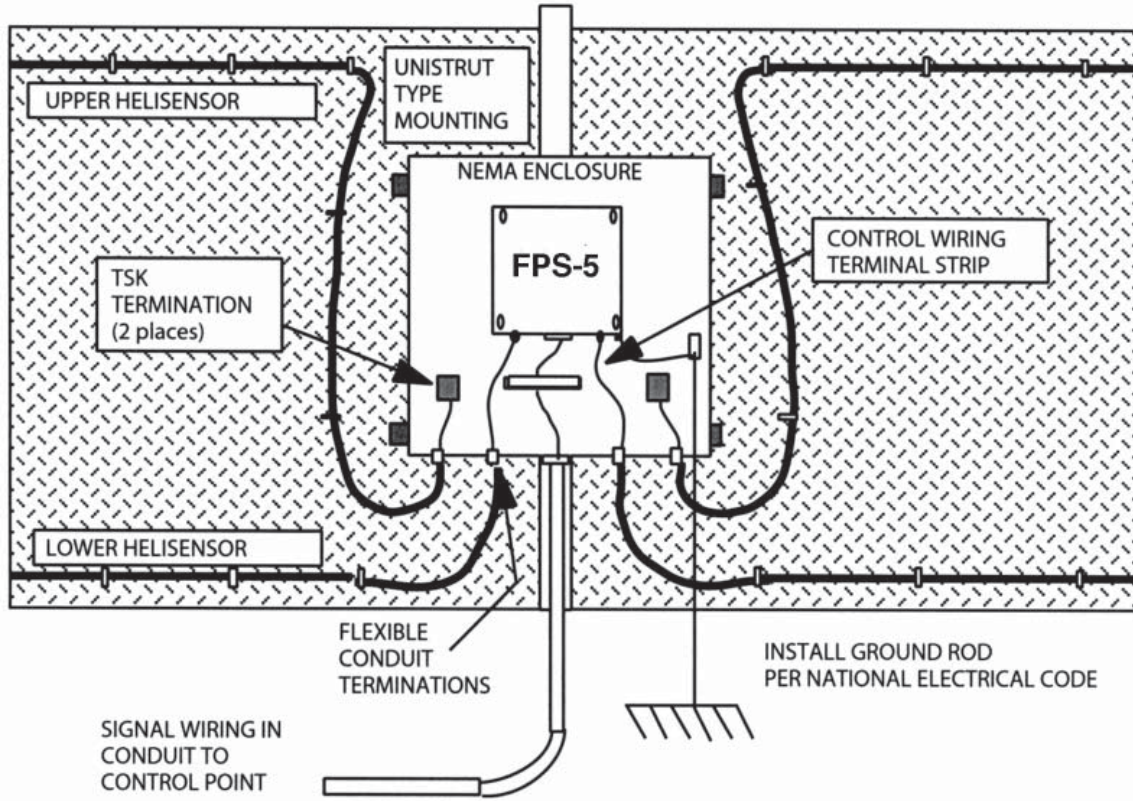

Figure 32. Helisensor Installation/Termination to NEMA Enclosure

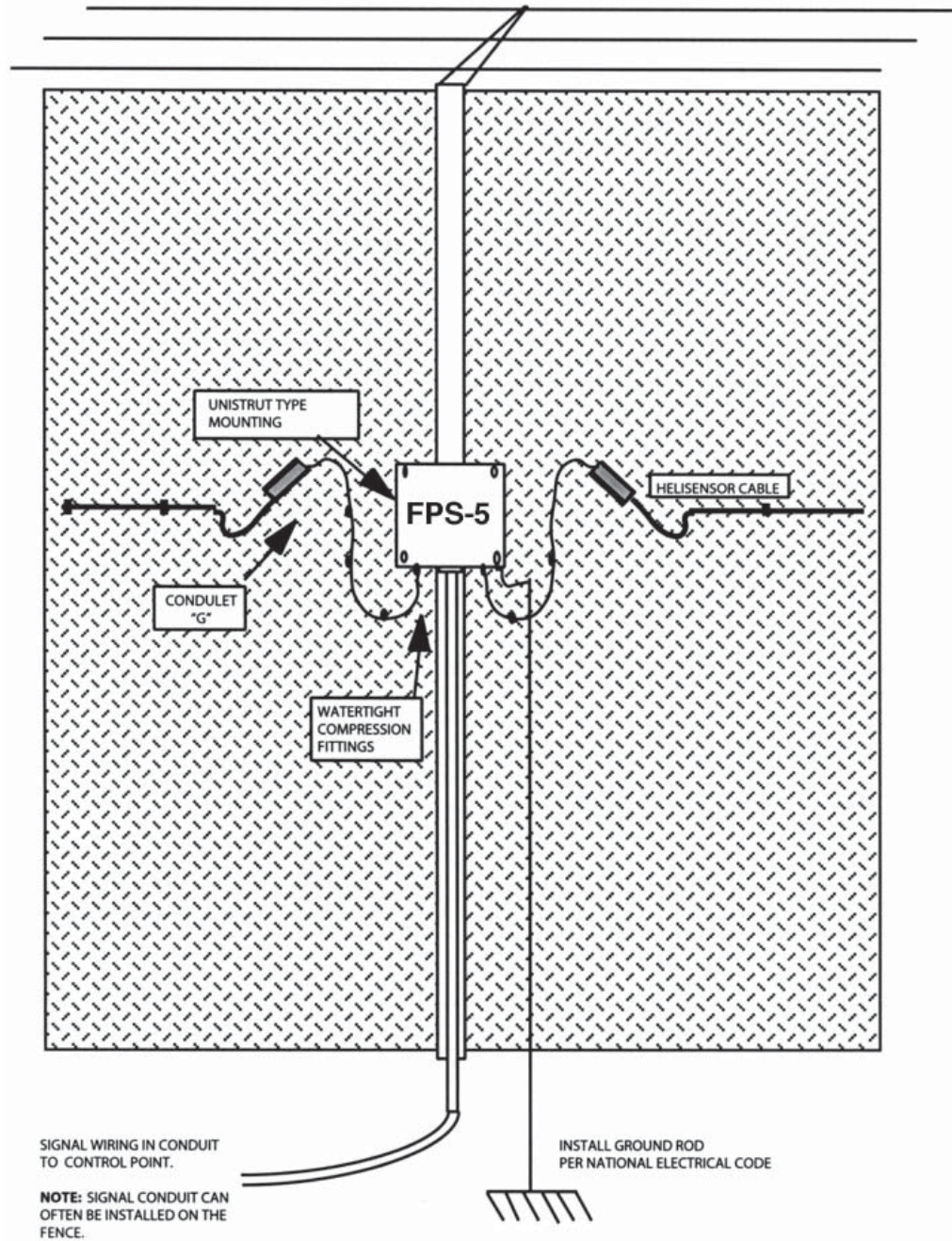

Figure 33. Retrofit Helisensor Termination to Standard FPS Processor

Condulet Installation

The Condulet circuit board has been re-designed with the end-of-line resistors built into the board and conformal coating to prevent moisture in the condulet from shorting the EOL resistors - a common cause of tamper alarms. This Condulet may be used for single or double end-of-line terminations or for splices. It may also be used for supervised "T" tap end-of-line terminations requiring a 2 meg-ohm end-of-line resistor.

1. Open cover and remove circuit board. Note that the circuit board is installed sideways with a plastic shield to insulate the board terminals from the Condulet enclosure. The 4 stand-offs lift the circuit board to prevent moisture accumulation on the board.
2. Clip the required jumpers according to the type of termination. See Figures 34-36.
3. Attach sensor cable(s) to terminal strip(s). Note that the sensor cable entering the left end of the Condulet attaches to the terminals on the right end of the circuit board and vice-versa for the right sensor cable. See Figure 34.
4. Re-insert circuit board sideways making sure that the plastic shield covers the terminals. Replace cover.
5. Condulet should be attached to the fence at a 45 degree angle with the cover facing out as shown. Allow a drip loop as shown to prevent water drainage into the Condulet. Do not position the Condulet with the cover facing up. See figures 39 and 41.

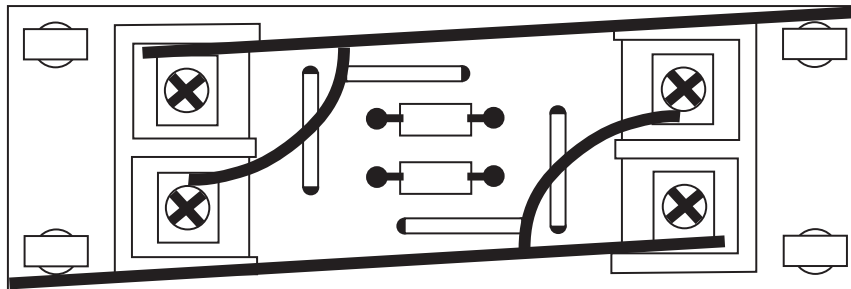

Figure 34. Transducer Cable Routing in Condulet

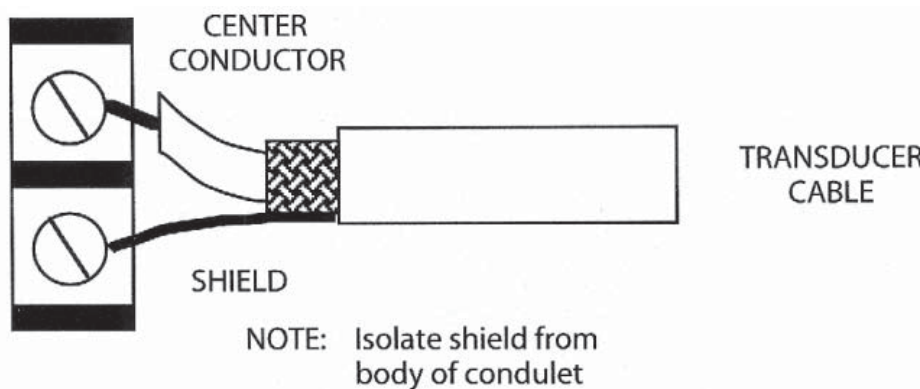

Figure 35. Transducer Cable Connection

For end-of-line termination, attach sensor cable to terminals as shown in Figure 36. Clip jumpers 2 & 4. For double end-of-line terminations, attach sensor cables to both terminals.

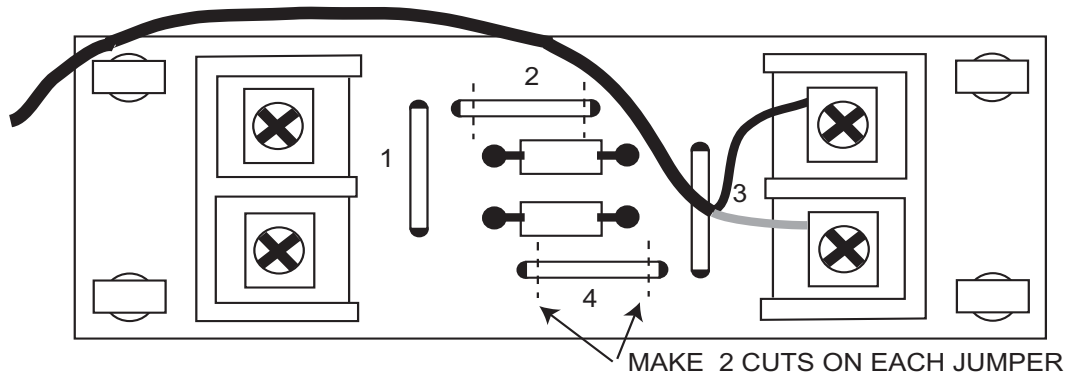

Figure 36. End-of-Line termination

Helisensor is provided in standard 100 meter lengths. Some applications may require longer zone lengths. The additional length is threaded into the conduit and the transducer cable is connected as shown in Figure 37. Clip jumpers 1 & 3.

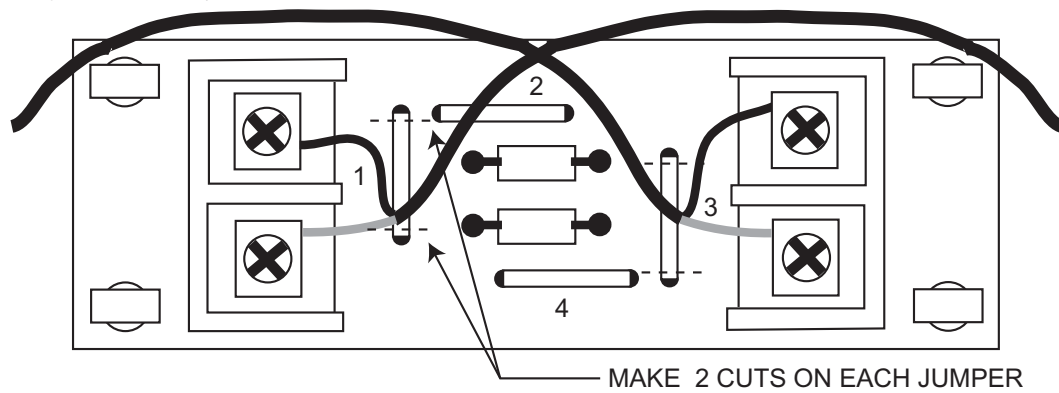

Figure 37. Splice Termination

In cases where the transducer cable is "T" tapped as in applications involving Telegates for gates, it is necessary to provide for supervision of both cables. This requires a 2 megaohm resistor at both the "T" section and the normal end-of-line. Attach the sensor cable as shown in Figure 38 and clip jumper 2.

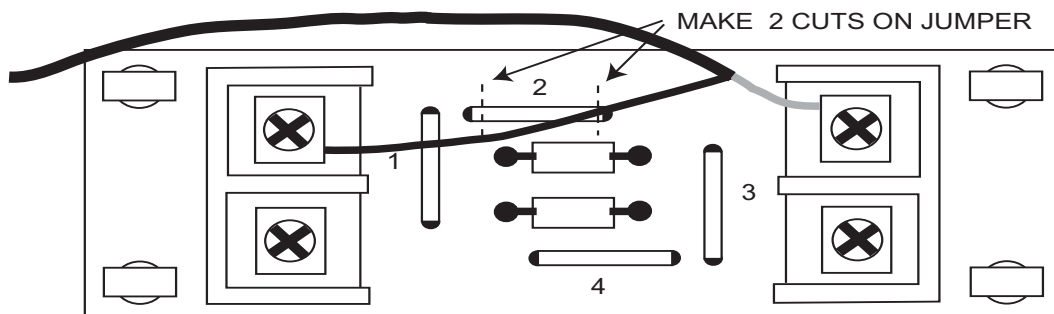

Figure 38. End-of-Line Termination With 2 Megaohm Resistor

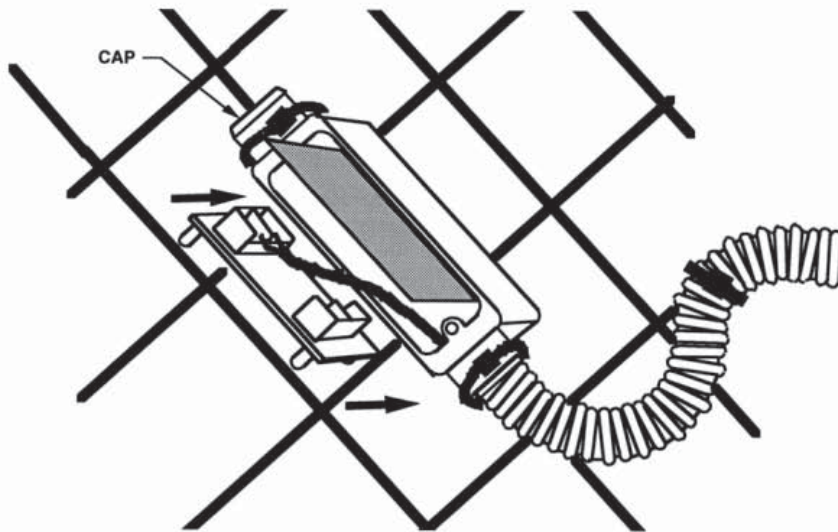

Figure 39. EOL Condulet Attached to Fence

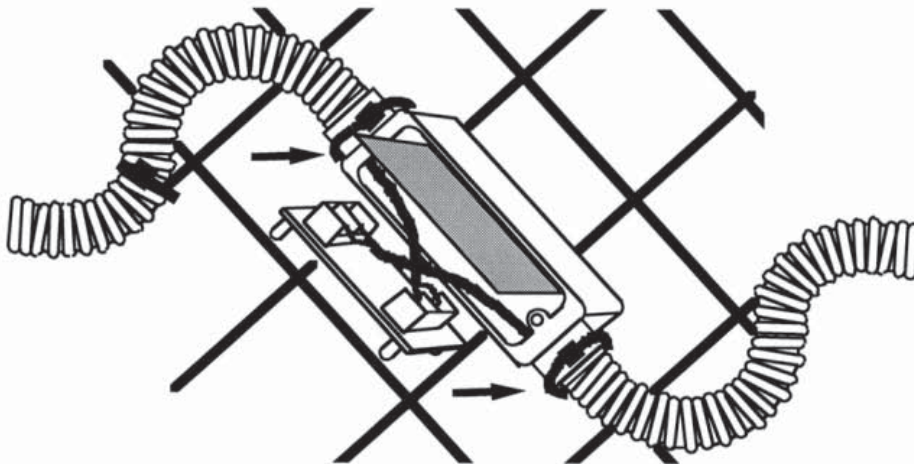

Figure 40. Condulet Splice Attached to Fence

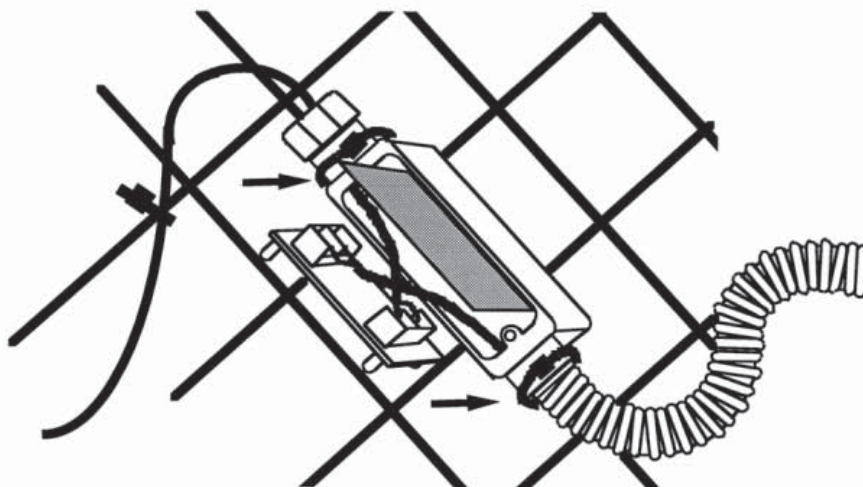

Figure 41. Condulet "G" Attached to Fence

Transducer Service Kit (TSK) Installation

Transducer service kits (TSK) are required for all end of line termination and splicing of standard transducer cable. TSK installation is very important to be sure that moisture does not affect transducer cable operation.

Each TSK consists of the service kit enclosure, a 1 Megohm, 1% metal film resistor preinstalled on the terminal block, and a cable tie for fastening to the fence fabric. The service kit enclosure is molded of sunlight resistant polymer with a conductive (copper) inner surface to maintain a proper shield around the termination. See Figure 42.

Proper preparation and installation of the transducer cable is essential to provide a water tight seal within the TSK. TSKs must always be installed with the cable entering the bottom. Each cable must have a drip loop so moisture is not allowed to collect near the cable openings. After splicing or termination, each TSK should be filled with Dow Corning 4 electrical insulating compound before sealing. The Dow 4 compound will keep moisture away from the terminations.

The transducer cable shield must be properly stripped and installed to contact the TSK copper shielding saddle on the inside edge of the cable entry. The inner conductor must be trimmed to the proper length to reach the termination screw.

To prepare each end of the transducer cable for TSK termination, proceed as follows:
(Refer to Figure 43.)

- Step 1: Strip outer insulation 1 inch from the end.
- Step 2: Pull braided shielding back 3/4 inch from center conductor and twist for insertion into terminator receptacle.
- Step 3: Strip center conductor insulation back 1/4 inch from the end and insert into one side of terminator receptacle and tighten lock screw.
- Step 4: Insert twisted shield into terminator receptacle next to center conductor and tighten lock screw.

NOTE: Prior to installing service kit cover, ensure the transducer outer insulation fits at the inside edge of the cable saddle on the service kit and that the shield contacts the saddle. This is very important to maintain a proper seal. Insulation too far inside the service kit may hinder closing the top cover and too far out may allow moisture to penetrate the enclosure. This may also interrupt the enclosure shield and allow (EMI) to enter the system.

Step 5: If splicing two sections of transducer cable, remove the preinstalled 1 Megohm resistor from the terminal block.

Step 6: Fill the TSK completely with the Dow Corning 4, or other approved, silicone grease.

Step 7: Install top cover, being sure it seats on all sides, and attach to the fence with a single cable tie.

CAUTION: Use only factory supplied or 1% metal film EOL resistors. Carbon and other resistors are not stable and must not be used.

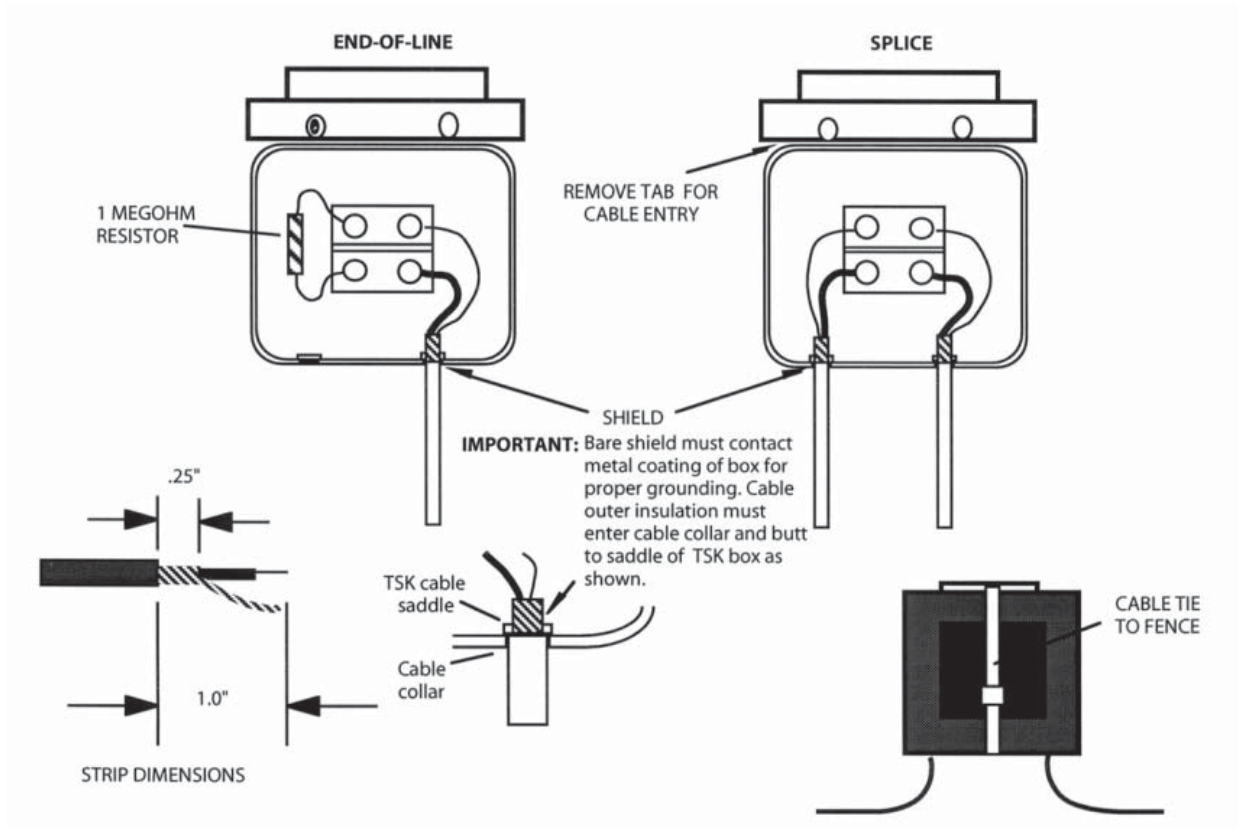

Figure 42. Transducer Service Kit

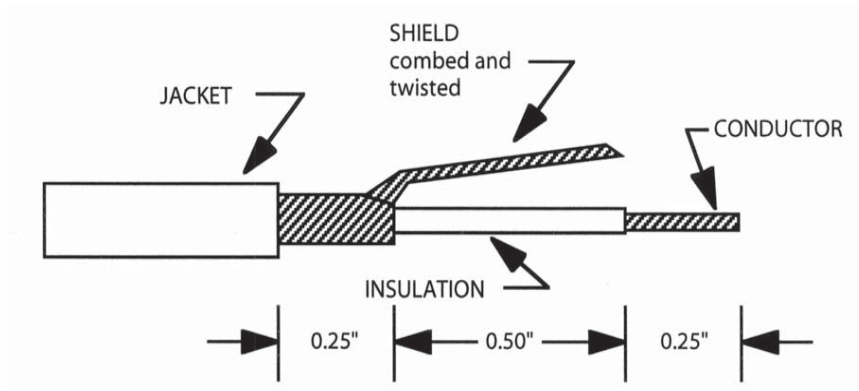

Figure 43. Transducer Cable Preparation

Gate Installations

Gates, including sally ports, require the same protection as the fence. There are many types of gates, but they are generally swinging or sliding. Additionally, gates can be installed as either single or double gates. Normally, gates are manufactured from the same fabric as the fence so the FPS transducer cable will provide the same level of protection.

Hinged (swinging) gates that are seldom used, such as gates used for maintenance, can usually be protected with transducer cable. High usage hinged gates can be protected in the same way but should probably be assigned their own alarm zone. Sliding gates are best protected using Telegate. Gate areas may also be protected using a nonfence-mounted sensor such as the MPS-4000 microwave system.

Swing Gate Installation

Transducer cable installation for a hinged gate is shown in Figure 44. This also applies to personnel gates. However, with the personnel type of gate, the conduit can be installed over the top of the gate if space permits. Two weatherproof, electrical junction boxes are mounted on the fence — one on either side of the gate as close as possible to an upright support post. These are interconnected by a 3/4-inch diameter conduit which is buried beneath the ground surface. The conduit depth should be a minimum 18 inches. NOTE: Nonsensitive cable must be used in the conduit connecting the two fence mounted transducer cables. Splice the nonsensitive cable to the transducer cable in each weatherproof junction box. Use a TSK to accomplish the splice [see Transducer Service Kit (TSK) Installation] and fill the TSK with Dow Corning 4 electrical insulating compound before sealing.

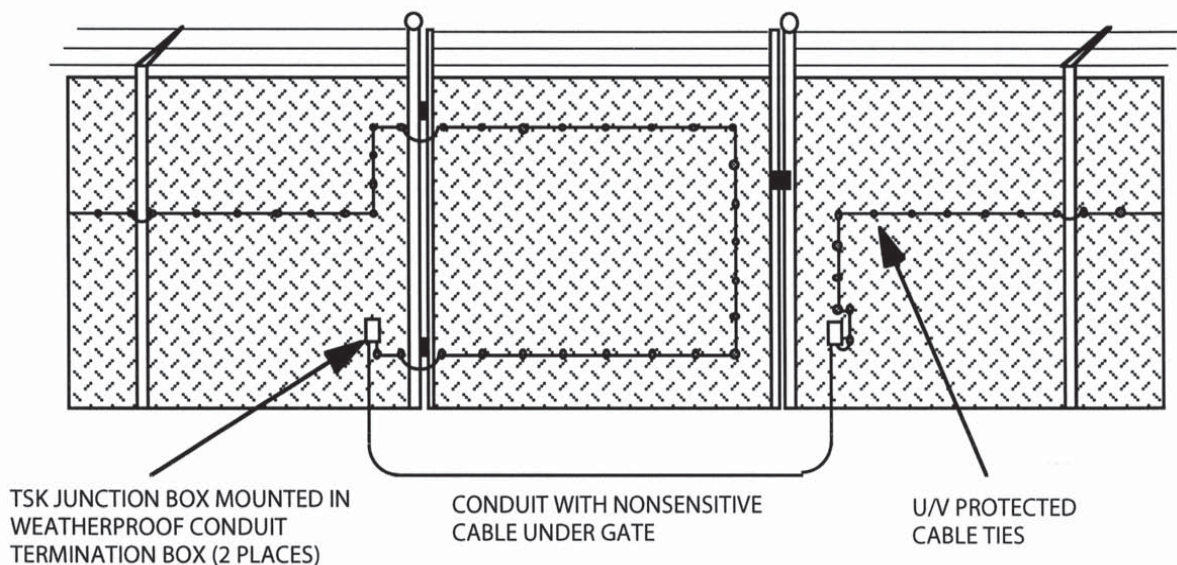

Figure 44. Hinged Gate Installation

As the transducer cable approaches the gate, it is tied to the fence fabric, turned and run up vertically approximately one foot, then turned horizontally and tied to the upright gate support post near, but not on, the upper hinge. Route the transducer cable across the gate support post and gate post using a strain relief, such as Panduit 1/8" T12F-0, or similar, spiral wrap material and fasten to the gate fabric as shown. The spiral wrap will prevent abrasion and excessive movement in the wind. Route the transducer cable in a large loop around the gate and return to the fence near the lower hinge point as shown. Utilize another strain relief to pass back across the hinge area to the fence fabric. Route the transducer cable on the fence to the weatherproof junction box making sure to provide the transducer cable drip loop shown and entering the junction box from the bottom (the drip loop and coming into the bottom will prevent moisture buildup in the junction box). A gland type cable fitting is recommended at the entrance to the junction box. Using a TSK, splice the transducer cable to the nonsensitive cable in the junction box. Route the nonsensitive cable in the conduit to the junction box on the other side of the gate. Splice here again to the transducer cable using a TSK and continue the transducer cable down the fence as shown. If a double swinging gate is encountered, the transducer cable should be routed and attached to the second half of the gate as explained for the first half.

Gate Bypass Unit

A gate bypass unit (GBPU) is sometimes used to temporarily disconnect the transducer cable installed on a swinging gate. If a GBPU installation is required, please refer to the Gate Bypass Unit Installation Instructions furnished with the GBPU.

Telegate Installation

Each Telegate requires installation of a support post. See Figure 45. The support post must be located correctly to ensure proper Telegate operation. The support post and Telegate must be positioned to extend and retract the armored nonsensitive cable as the gate is opened and closed.

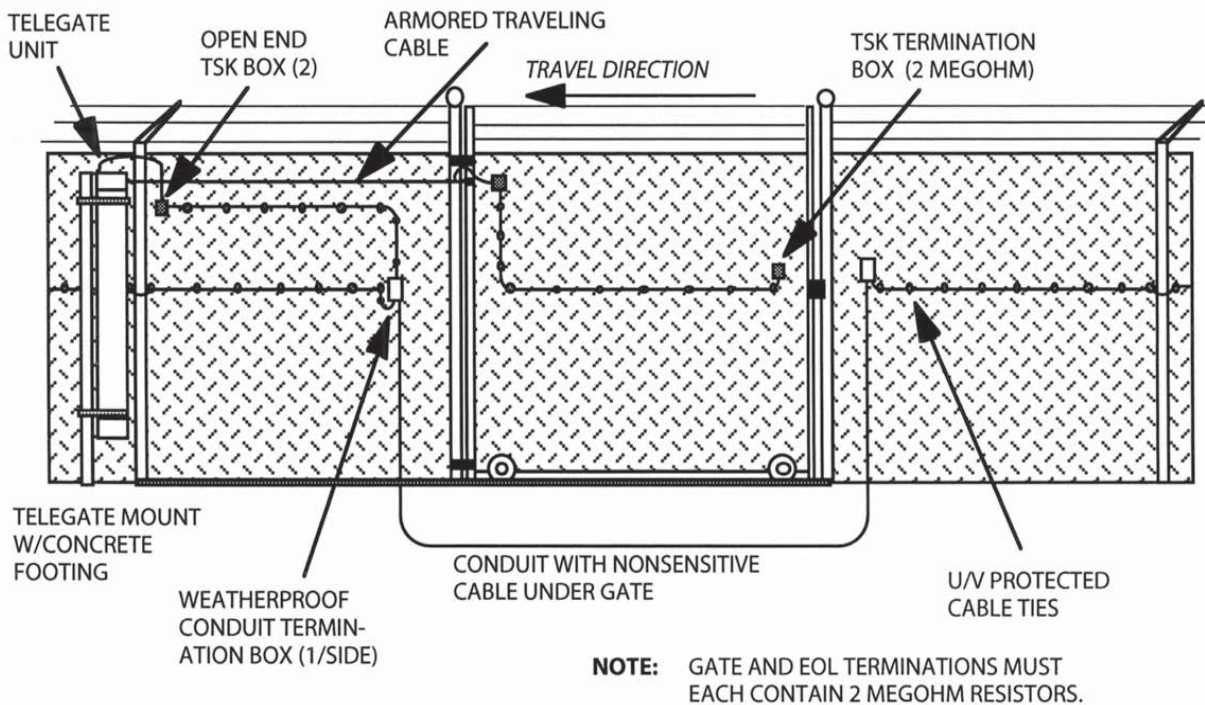

Figure 45. Telegate Installation

The recommended position of the support post for each Telegate is approximately 5 feet from the end of the sliding gate when opened to the maximum position, and not less than 1 foot or more than 2 feet from the centerline of the fence posts on the gate side of the fence. See Figure 46. A 4-inch support post is recommended. The post material should be the same as the fence posts. The support post height must be sufficient that the support post is as tall as the fence and a minimum of 10 feet above ground level. A minimum of one foot space is required between the Telegate bottom and the ground to allow for drainage. The support post footing should be 24 inches deep minimum.

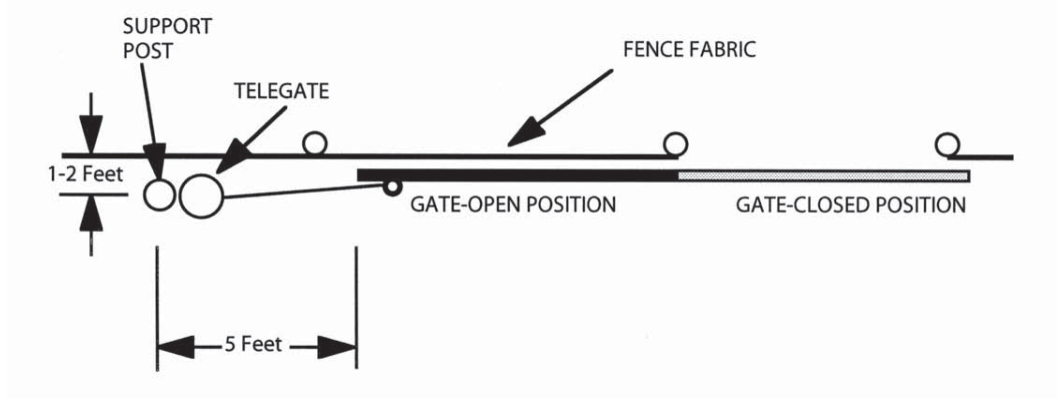

Figure 46. Telegate Support Post Location

Unless the Telegate is exactly at the end of an FPS zone or its own FPS zone, a conduit must be run under the gate opening to continue the zone wiring as shown in Figure 45. This conduit should terminate on each fence section using weatherproof electrical bell boxes and TSKs as shown. It is recommended that the support posts, conduit and gates be installed before the Telegate is unpacked and installed.

Each Telegate is shipped completely assembled and is packed in a wooden crate. The Telegate has a 65-pound weight secured in the middle of the PVC tube enclosure. The weight is held in place for shipping between a cable to the bottom cap and the armored cable and pulleys. Unpacking and preparation for installation involves removing the Telegate from the crate, removing the bottom cap, uncoiling the armored cable and lowering the weight to the bottom of the tube. Uncrate and set up each Telegate as follows:

CAUTION: Once a Telegate is unpacked and the weight and pulley systems are released, the Telegate should remain upright with pull on the armored cable so the cable is not allowed to fall off the pulleys and become tangled. Unpacking the Telegate at the installation location is recommended.

- Step 1 Lay the crate on its side with the top side up. Remove the top of the crate.
- Step 2 Carefully remove the Telegate assembly from the crate.
- Step 3 Remove the cable retaining bolt located in the center of the bottom cap. Removal of this bolt releases the cable that is holding the 65 pound weight in place.

- Step 4 Remove the bottom cap by first removing the three 1/4-inch screws. Remove the cap by gently tapping the lip.
- Step 5 Remove the cable tie and tape and uncoil the armored cable at the top of the Telegate tube. Be careful because when you uncoil the cable the weight can fall to the bottom of the Telegate tube. Hold the armored cable and gently lower the weight to the bottom of the tube.
- Step 6 With the weight at the bottom of the tube, remove the screw and cable attached to the bottom of the weight.
- Step 7 Gently pull on the armored cable to verify that the weight is moving freely in the tube.
- Step 8 Replace the bottom cap using the three 1/4-inch screws. You may wish to store the shipping bolts and cable in the cap in case you ever have to remove and ship the Telegate.
- Step 9 The Telegate is ready for installation.

Attach the Telegate to the support post using the two stainless steel bands provided. See Figure 45. Locate each band approximately as shown. Aim the cable outlet located at the top of the Telegate so the armored cable will pay out straight to the gate. Each band must be tight enough to hold the Telegate in place but not distort the Telegate enclosure.

Open the gate to the maximum opening and attach the Telegate armored cable to the gate using the insulated shackle furnished. The shackle should connect to an eyebolt or other similar device attached to the gate at or near a point that keeps the cable pull horizontal as shown. Leave a minimum 1 foot pigtail for terminating the armored cable to the transducer cable being installed on the gate.

Before making any further connections, operate the gate from full open to full closed making sure that the Telegate armored cable is extended and retracted correctly. Make required mechanical adjustments before Telegate electrical connections.

Two short sections of nonsensitive cable are furnished with each Telegate to make connections. Terminate the nonsensitive cable running from the top of the Telegate to a TSK mounted on the fence as shown in Figure 45. Route nonsensitive cable from the TSK to the bell box as shown. Fill all TSKs with Dow Corning 4 silicone grease, or equivalent, before sealing.

Terminate the armored cable to the transducer cable being installed on the gate using a TSK located approximately as shown. Install the transducer cable on the gate in the same manner as the fence. Terminate the other end of the gate mounted transducer cable with another TSK. To maintain supervision of all transducer cable in the zone, the TSK at the end of the gate mounted transducer cable must contain a 2 Megohm resistor, and the TSK at the end of the FPS zone must also be a 2 Megohm resistor to maintain the net 1 Megohm supervision of each FPS zone.

CAUTION: Use only factory supplied or 1% metal film EOL resistors. Carbon and other resistors are not stable and must not be used.

Microwave Gate Protection

The Magal-Senstar MPS-4100 microwave system provides coverage of the area around a gate while allowing the gate to move freely. See Figure 47. The FPS transducer cable can terminate at the end of a zone on either side of the gate or nonsensitive cable can be spliced and run underground in conduit to continue the zone. The MPS-4100 is available with three different antenna patterns for varying protection widths.

Please see the MPS-4100 Installation and Operation Manual for installation information.

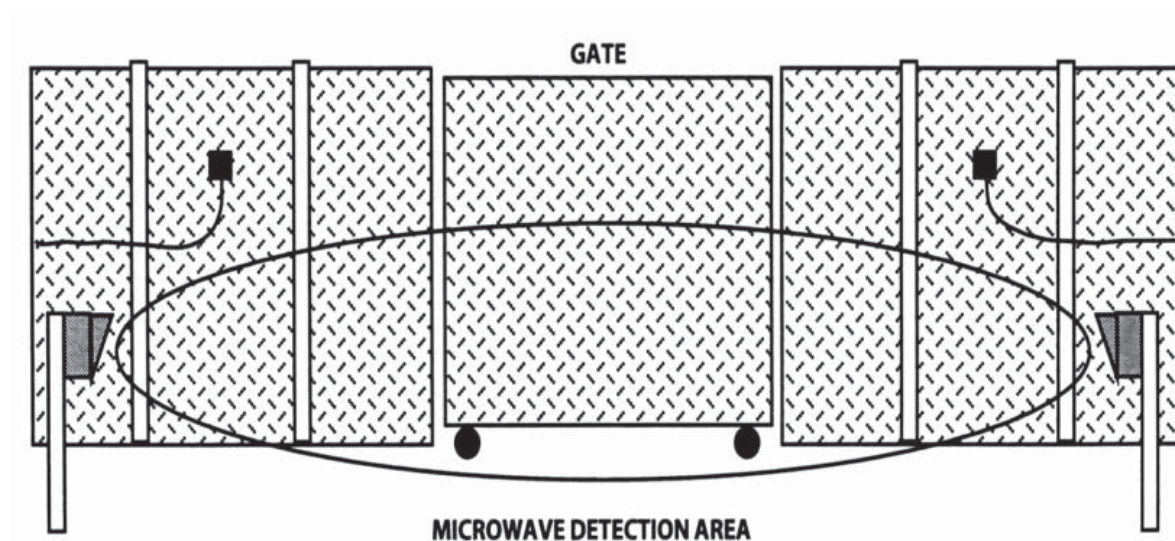

Figure 47. MPS Microwave System

Transducer Cable Connections

The alarm processor transducer cable connections are very important to the operation of the sensor system. Before proceeding with transducer cable terminations, the transducer cable should be completely installed and terminated in the zone and the transducer cable extended through the conduit and/or the processor cable glands into the processor enclosure. To connect the transducer cable to the processor, proceed as follows:

- Step 1: Strip outer insulation of the transducer cable 1 inch from the end.
- Step 2: Open the entry gland by rotating the outer shell one full turn counter clockwise.
- Step 3: Pull transducer cable through to the inside of the processor enclosure.
- Step 4: Pull braided shielding back 3/4 inch from outer conductor and twist.
- Step 5: Strip center conductor insulation back 1/4 inch from the end.
- Step 6. Attach the center conductor and the braid to the removable connector plug located on the lower corner of processor board as shown in Figure 46. Be sure to separate shield and center

conductor at terminal block to avoid noise in audio.

Step 7 Allow enough transducer cable inside the processor enclosure to permit future service.

Step 8: Close the entry gland by rotating clockwise the outer shell until the cable is held snugly. DO NOT OVERTIGHTEN!

Interconnect Wiring

Each FPS processor requires wiring connection to the power supply and the central alarm system.

The FPS-5 includes a transponder circuit board which enables multiplex CEnDe communications to the Magal-Senstar MXF-5500 Security and Control Center. The transponder card requires the proper code to communicate with the control centers.

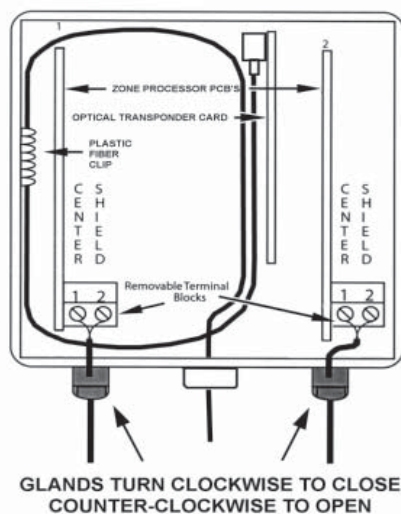

- Fibers are routed in large smooth loop.

Figure 48. Transducer Cable Connection

FPS-5 connections consist of power, and fiber optic cable for data and audio. Figure 49 shows the typical connections to the FPS-5. Refer to the MXF-5500 Installation and Operation Manual, Appendix A, for power supply calculations and information when powering more than one FPS-5 on one power supply line.

Note that in most installations the power lines run in a daisy chain fashion from one processor to the next. See the FPS Design Guide for more information.

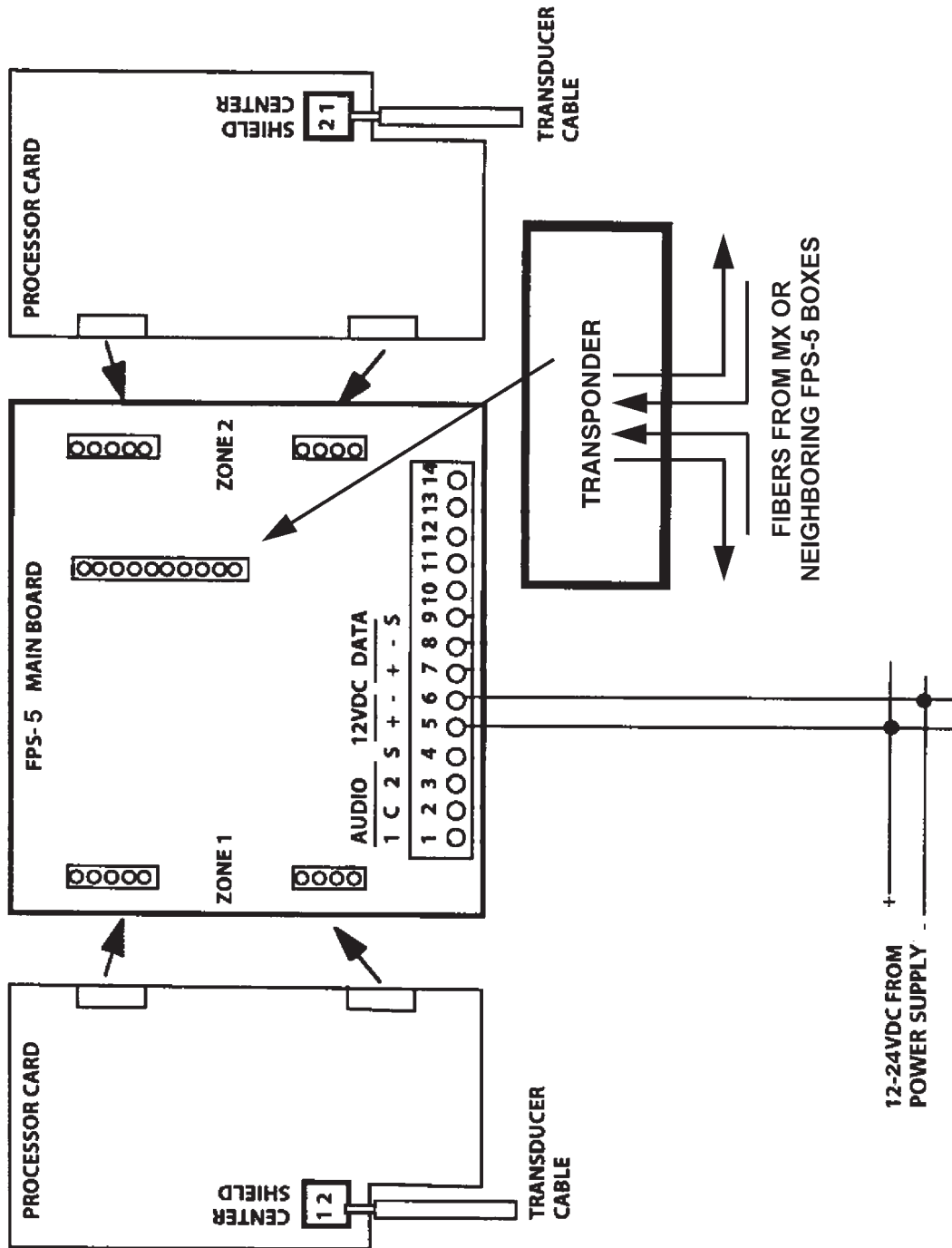

Figure 49. FPS-5 Wiring Connections

6 INITIAL SETUP AND ADJUSTMENT

Processor Adjustments

Initial setup and adjustment consists of setting option jumpers and transducer cable gain and count switches. Switches and jumpers are located on each processor circuit card, so there are two sets of switches, one for each processor zone. Jumpers are also located on the main board. Settings differ when you are installing an EDAPT capable processor. Refer to the correct paragraphs before proceeding.

Control Switches

There are two (2) multiposition switches and a LED located on each signal processor board: (See Figure 52.)

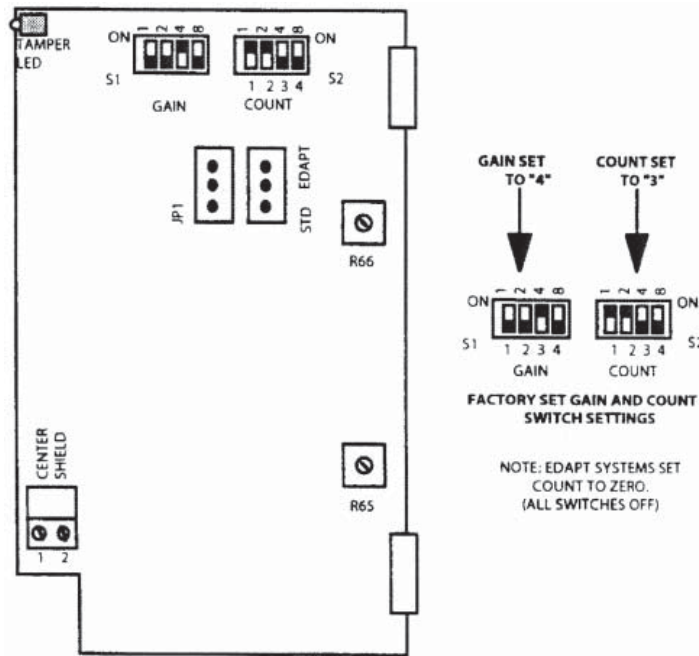

Figure 50. Processor Adjustments

Gain Switch S-1. This switch is a four position dip switch set in a binary code for values from 1 to 10. This switch controls the signal processor sensitivity. The higher the number, the more sensitive that zone becomes. The factory setting for the gain switch S-1 is 4.

Count Switch S-2. This switch is a four position dip switch which determines the number of distinct intrusion related events or impulses required by the processor within a certain time frame in order to produce an alarm. This switch is set with a binary code for values from 1 to 9 (0 is a false condition which will cause the processor to stay in constant alarm). The factory setting for the count switch S-2 is 3. EDAPT systems must have the count set to 0 (all switches off) since the count information is being sent to the MXF-5500 for processing.

NOTE: When setting the processor gain (S-1) and count (S-2) switches for any particular Installation, many variables have to be taken into account. Some of the more common are:

- ▷ Condition of fence (taut, loose, coated, painted)
- ▷ Environmental conditions (high winds, heavy hail, falling ice)
- ▷ Activity around fence (people, livestock, shrubbery)
- ▷ Height of fence
- ▷ Degree of security required
- ▷ Local or remote alarm response

In optimizing the processor for a minimum of nuisance type alarms, you must set a criteria for good detection. In a typical installation, criteria required to detect a climber will subsequently detect other forms of penetration through the fence. During testing (detailed in Section 7), the gain and count switch settings may be readjusted to provide consistent detection over the entire fence protection system.

Jumper JP-1 must be set to select either standard or EDAPT operation. Select the bottom two pins for standard operation, or select the top two pins for EDAPT operation. Jumper JP-1 must be set to standard for FPS-5 operation.

Tamper LED. (No adjustment required, test only) When the lid to the signal processor is off, the tamper circuit is activated. This will illuminate the LED on the zone 1 processor card. To test the circuit, depress the tamper switch on the FPS-5 Main Board and the LED will extinguish.

NOTE: Pulling out on the tamper switch temporarily provides a tamper switch shunt. Shunting the tamper switch allows testing without presence of a constant tamper alarm.

Variable Resistors (Information Only, DO NOT ADJUST)

Each plug-in processor card contains two variable resistors, R65 and R66. These resistors are factory set and normally require no field adjustment. The following information is provided for information only. DO NOT attempt to adjust either R65 or R66 unless directed to do so by the factory.

- ▷ R65 is set at the factory for an output voltage of 5.9 VDC to 6.1 VDC at test point 7.
- ▷ R66 is an adjustment that varies the alarm time (pulse width). R66 is factory set for 1.5 seconds.

Main Board Jumper Settings

The main board has jumpers which must be set to configure the processor for either standard or EDAPT operation. By factory default, jumpers are configured for Standard operation. Jumpers are set to EDAPT only when the unit is being used with an EDAPT configured MXF-5500 system.

FPS-5 processor boards use an on-board logic circuit to separate the tamper indications for the left and right zones. Separated tampers are configured through jumpers JP6 and JP7 on the Main board and through programming in the MX control. Refer to Figure 53 for jumper setting information. Verify that ALL jumpers are set correctly.

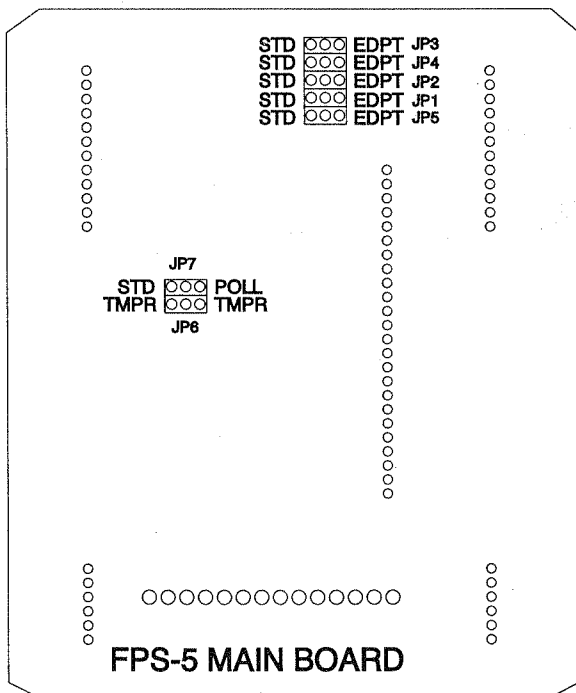

JP	STANDARD	EDAPT COMBINED TAMPERS	EDAPT SEPARATE TAMPERS
1	STD	EDPT	EDPT
2	STD	EDPT	EDPT
3	STD	EDPT	EDPT
4	STD	EDPT	EDPT
5	STD	EDPT	EDPT
6	STD Tmpr	STD Tmpr	POLL Tmpr
7	STD Tmpr	STD Tmpr	POLL Tmpr

Figure 51. FPS Main Board Jumper Settings

CAUTION: If all jumpers are not set correctly, alarms may not be reported.

FPS-5 Transponder Board Settings

Transponder Address

The FPS-5 processors communicate with the MXF-5500 using standard address codes to identify their location. There is a transponder address (data coming to processor). Consult the MXF-5500 Installation and Operation manual for the proper address codes.

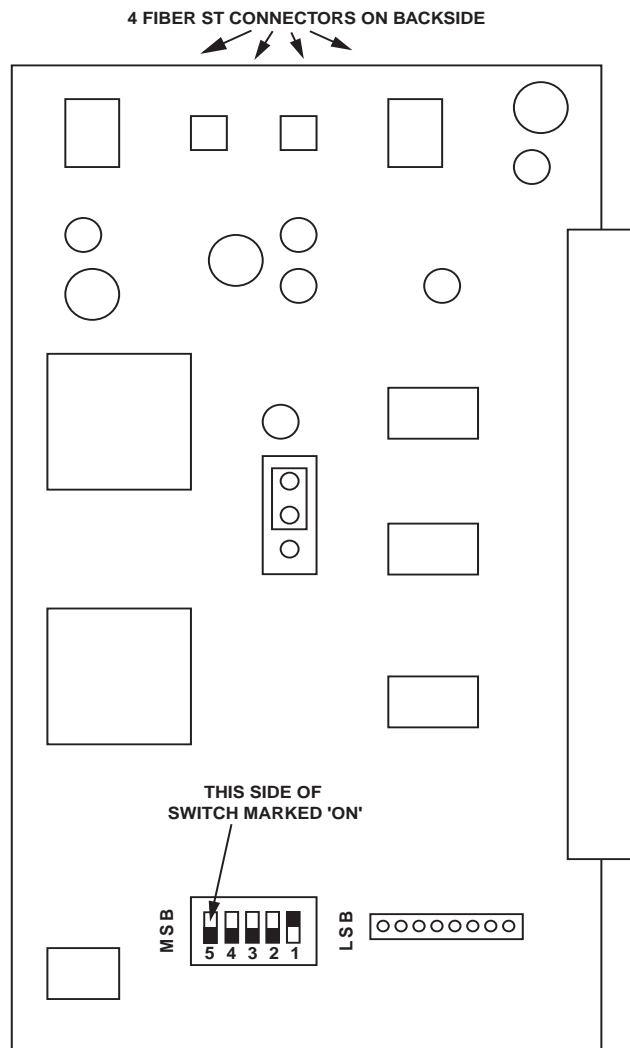

Figure 52. FPS-5 Transponder Board



NOTE: Hold Transponder card as shown in Fig.52 and set dip switches as shown

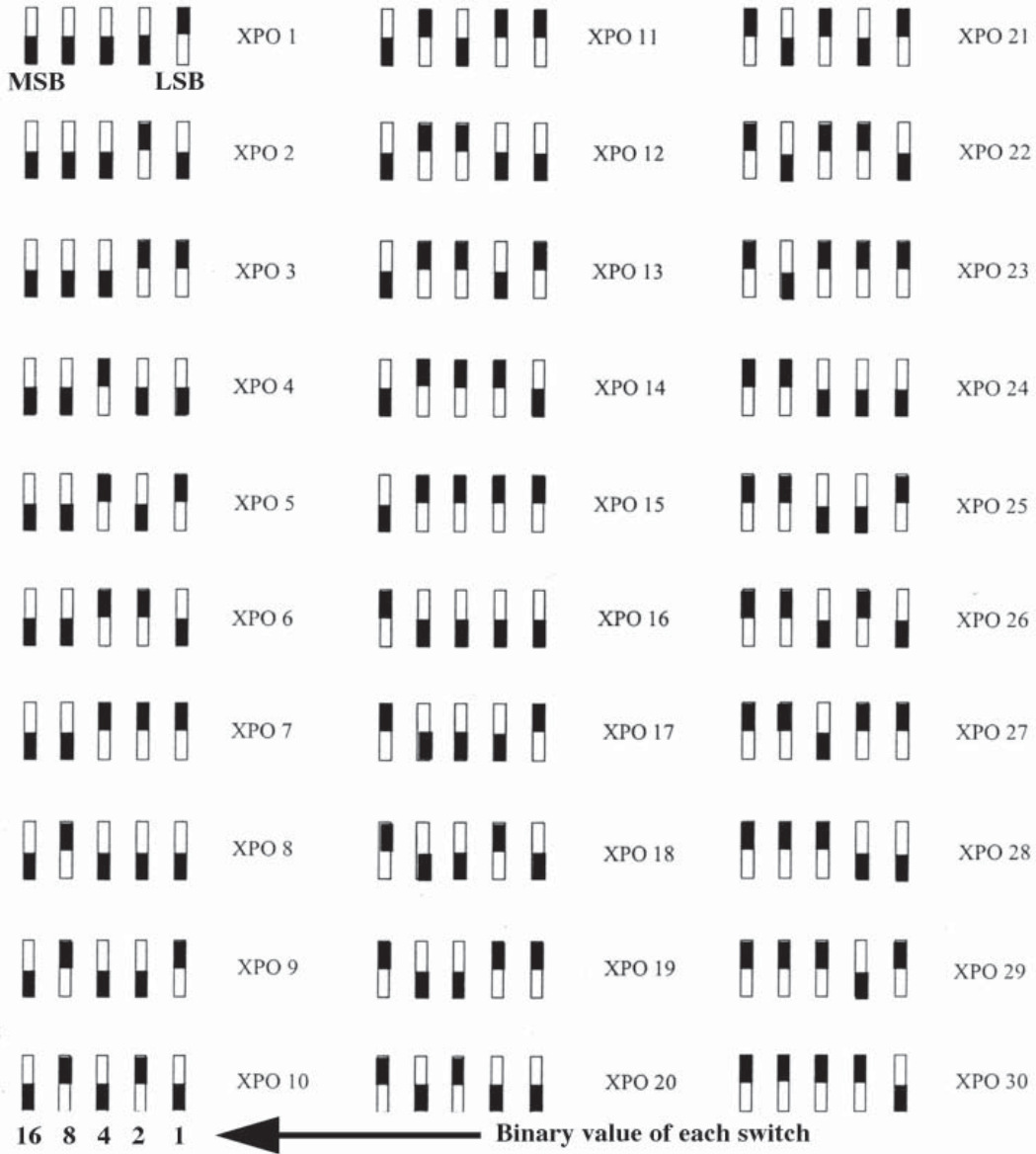

Figure 53. FPS-5 Switch Settings

7 SYSTEM STARTUP AND TESTING

General

System startup and testing consists of powering up the system and making tests to verify proper operation and detection of fence disturbances.

Initial testing consists of verifying the continuity and integrity of the transducer cable installed in each zone and the power supply to each processor. Subsequent testing will test alarm detection of the fence protection system.

A good quality ohmmeter, capable of reading 1 Megohm plus or minus 10% and resistances of up to 10 Megohms is required. A Monitor Series IV Test Set is highly recommended. The Monitor Series IV will allow complete testing of each processor without having to communicate with the central alarm point which is usually well away from the fence alarm zone.

Transducer Cable Tests

Perform the following tests to verify that the transducer cable is properly installed and free from shorts or grounds:

Visually inspect the entire length of the transducer cable to verify proper installation, free of abrasions or breaks in the outside jacket. Pay particular attention to the following:

- ▷ Where the cable crosses each fence post.
- ▷ Service loops every 40-50 feet. (Every 100 feet with Helisensor.)
- ▷ Special conditions at corner posts and ends of zones.
- ▷ The installation of each TSK.
- ▷ Silicone grease in each TSK.
- ▷ Drip loops provided at each TSK, EOL conduit and processor.

Perform the following continuity tests on each zone of transducer cable with an ohmmeter capable of reading 1 Megohm \pm 10%!

CONTINUITY TEST	NORMAL READING
(a) Center conductor to shield	900 K ohms to 1.1 M ohms
(b) Shield to fence	10 Megohms, minimum

In (a) above, if the reading is not within the prescribed limits, probable causes are:

- ▷ A short between the center conductor and shield.
- ▷ Improper value/tolerance of end-of-line resistor.
- ▷ Poor installation of end-of-line resistor.
- ▷ Omission of end-of-line resistor.

In (b) above, if the reading is other than noted, the cause is due to a break or abrasion in the outer jacket of the transducer cable, causing a short between the shield and the fence fabric. DO NOT continue with testing until the problems have been found, repaired, and an acceptable resistance measurement is attained. Utilize TSK service kits and additional transducer cable to repair defective lengths of transducer cable. Refer to Transducer Service Kit (TSK) Installation section.

Power Supply Measurement

The power to an FPS-5 processor must be between 12 and 24 volts DC. Measure the input voltage at processor terminals 5 and 6. If the voltage is not within these limits, correct the voltage problem before proceeding.

If your system utilizes FPS-5 processors with processor power distributed from a central point, refer to the MXF-5500 or DCU Installation and Operations manual, Appendix A, for additional information.

Fiber Optic Power Measurement

Using a 1 meter fiber and a fiber optic power meter, the Tx outputs of loop and transponder cards will nominally measure -14dBm. If the received power seen by the Rx inputs of loop and transponder cards falls below 127dBm (13.5dBm power budget) operation cannot be guaranteed. The information is sent down the fiber using a LED with a 850nm wave length. This is visible red and should not cause eye damage. Active Tx connectors and fibers should have a red dot at their centers.

Signal Processor Operational Test

Operational tests consist of sequentially testing whether the FPS system will detect cutting or climbing in each alarm zone. This testing should be conducted prior to any full system tests with the customer.

The recommended test equipment is the Monitor Series IV test set. The test set plugs directly into the processor and allows direct read out of alarm conditions. If you do not have the Monitor Series IV test set, you will have to rely on communications (radio or ?) for alarm indications from the alarm monitoring point. Connect the Monitor Series IV using the instructions furnished with the unit.

General Test Conditions

Testing should be conducted at each fence panel where transducer cable is installed. You will simulate cutting noises on the fence and see whether the processor generates an alarm each time you simulate a cut.

The processor gain and count switches control the level of cutting and climbing that will produce alarms. In Section 6, you initially set the gain and count switches to normal levels.

The gain switch sets the overall sensitivity of the fence and should not be changed until some testing in that fence zone is complete. The count setting changes the number of cut clicks that must be detected by the system before an alarm is generated. If the set number of counts is equaled or exceeded, the processor will indicate an alarm.

Fence testing is conducted by tapping the fence with a metal screwdriver or similar object generating a noise that is similar to a cut. Tap the fence panel four times (for a count setting of 4), at about a once per second rate. On the fourth tap the processor should show a zone alarm. Continue the test within each fence panel.

Testing Using Magal-Senstar’ Field Test/Monitor Unit.

NOTE: The Field Test/Monitor Unit can be used to test the FPS-5 unit.

- Step 1. Remove processor cover.
- Step 2. Verify that the signal processor gain switch S-1 is set to 4.
- Step 3. Verify that the signal processor count switch S-2 is set to 3.
- Step 4. Verify that each transducer cable is connected to each processor circuit card.
- Step 5. Unplug the removable 14-pin terminal connector from the FPS-5 Main Board, TB-1, and plug in the field test/monitor unit paddleboard. Follow the procedures provided with the monitor unit.
- Step 6. A tamper alarm should be generated when the cover is removed. Pull out tamper switch to shunt the tamper alarm.
- Step 7. Tap the transducer cable with a screw driver four times, pausing slightly between taps. An alarm indication should be generated after the fourth tap.
- Step 8. Continue testing by tapping the fence fabric within each fence panel in the zone. Reset the tester after each test.
- Step 9. Reassemble the processor when the tests are complete.

REPEAT THIS TEST FOR EACH ZONE.

NOTE: IF ANY OF THE ABOVE TESTS FAIL:

- Step 1. Recheck procedure and connections.
- Step 2. Assure tester batteries are fully charged.
- Step 3. Check sensor cable per transducer cable tests.
- Step 4. Refer to Fence Quieting, Section 4.
- Step 5. See troubleshooting section.

Sensitivity and Count Adjustments

Each FPS zone processor is factory set for a sensitivity (gain) setting of 4 and a count setting of 3. This will provide excellent fence protection operation in many installations. However, each FPS zone should be thoroughly tested to determine if additional adjustments are required to make the zone more, or less, sensitive.

Generally speaking, increasing the gain in the zone also increases the possibility of nuisance alarms. As

the gain is increased, the fence is more susceptible to producing alarm counts from movement, wind, etc. Increasing the count in the zone decreases the possibility of nuisance alarms by requiring more qualifying hits (hits that exceed the gain threshold) to produce an alarm. Sensitivity should be determined by tapping on the fence fabric at various points along each fence panel with a metal object, such as a screwdriver, **and** by actual climb tests.

When making adjustments, the gain switch is used as a course adjustment, while the count switch is used for the fine adjustment.

NOTE: Count adjustments for EDAPT systems are made at the MXF-5500.

System Checkout

By the time you are ready for system checkout and final testing, the transducer cable and signal processor should be installed and operating properly and the operational tests should be complete.

System checkout usually involves testing the complete system from the fence to the central control point including alarm control and remote alarm annunciation. If you are using one of PPI's monitor/display options, refer to the appropriate manual for check-out and operation:

MXF-5500 Series Control Unit
Data Collection unit (DCU)

If you are using another type of monitor, be sure to check out its operational functions thoroughly.

The system test is performed by having a person climb each fence panel and verifying that the climb has been detected. This should be done using someone weighing in the range of 100-130 pounds. Have the test subject climb the fence at various locations within the system, and within each fence panel if possible. It is from this type of testing that you will gain the information necessary to properly adjust the signal processor gain switch S-1 and count switch S-2 on the processor circuit card.

IMPORTANT: BE CAREFUL NOT TO DAMAGE THE SENSOR CABLE WHILE PERFORMING CLIMB TESTS.

Be sure to perform the climb test for each zone. It is not uncommon to have different gain and count settings on different signal processors within a multiple zone system. Remember, the switch settings are designed to allow the sensor to be customized for fence conditions, height, and customer requirement.

IMPORTANT: GENERALLY SPEAKING, THE CALIBRATION TESTS DESCRIBED IN THIS SECTION ARE FOR FACTORY-TRAINED TECHNICIANS TO PERFORM IN THE INITIAL AND PERIODIC CALIBRATION OF THE SYSTEM. THESE PROCEDURES ARE NOT RECOMMENDED FOR NON-TRAINED PERSONNEL THAT WISH TO VERIFY THE FUNCTIONALITY OF THE SYSTEM AT MORE FREQUENT INTERVALS.

THE MORE FREQUENT FUNCTIONAL TEST CAN BE CONDUCTED BY TAPPING FIRMLY ON THE FENCE FABRIC AT A RATE OF ONCE PER SECOND AS MANY TIMES AS REQUIRED BY THE COUNT LEVEL SETTING. THE TESTING DEVICE SHOULD BE A METAL OBJECT OF SUFFICIENT SIZE TO GENERATE A "HIT" WITH EACH STRIKE OF THE FABRIC. BE SURE TO STRIKE AWAY FROM THE ACTUAL SENSOR CABLE TO AVOID DAMAGING IT.

8 MAINTENANCE / TROUBLESHOOTING

General

The entire system will continue to perform efficiently only if it is properly maintained. It is highly recommended that the entire system be thoroughly tested and tuned once every three to four months.

The Fence

This is the portion of the system that will require the largest share of maintenance. **THIS IS IMPORTANT!** Fence conditions can deteriorate rapidly due to:

- ▷ Severe winters
- ▷ Strong winds
- ▷ Growing shrubbery and trees
- ▷ Employees stacking material against fence or running into it with vehicles
- ▷ Old signs working loose or facilities personnel installing new signs
- ▷ General weakening of fabric-to-support tie-down connectors

During each maintenance check, be sure to test all fencing as outlined in Section 4, making sure that it is still quiet! If necessary, quiet the fence as described in Section 4.

The Transducer Cable

The transducer sensor cable is designed to withstand years of weather and environmental conditions. It is important, however, that you give attention to the following areas:

Visually inspect all cable runs making sure:

- ▷ Cable is taut (but not bowstring tight).
- ▷ All cable ties are intact.
- ▷ End of line resistor and any splices are properly sealed.

Perform cable continuity tests as outlined in Section 7.

Transducer Cable Repair

If the transducer cable is damaged by an abrasion or cut, one or both of the following conditions may exist.

- ▷ The outer shield will short directly against the fence fabric.
- ▷ Moisture will cause a partial short between the center conductor and the outer shield, thereby shorting the end-of-line supervision resistor (1 Megohm) to below the tolerance level of 900 K ohms. This in turn will cause the signal processor tamper alarm to go into an ALARM STATE until the damaged area is repaired.

NOTE: Tamper alarms caused by moisture penetration can be intermittent.

To repair a damaged transducer cable, splice kits are available from MSI that require no special tools and can be performed in about 5 minutes. (See Section 5, TSK Installation)

Systematic Testing

Problems sometimes occur due to equipment failures. However, in most cases, problems are caused by human or installation related items such as:

- ▷ Shipping damage
- ▷ Disturbed wiring or connections
- ▷ Incorrect connections
- ▷ Physical damage
- ▷ Defects in the fence installation

Always look for the simplest problem first. For example, always check for power supply voltages before starting any further testing.

When approaching a system malfunction, look first for a related activity that could have caused the problem. This will help you go directly to the possible problem areas and/or obtain more accurate factory assistance. Examples are:

- ▷ Recent maintenance actions or installations of other equipment in the same area or equipment rooms.
- ▷ Water or lightning damage.

Factory customer assistance is available to help you find and correct system errors. It is important that you keep your as-built documentation and test records so the factory will have the data needed to help resolve your problem.

Problem Identification and Resolution

Table 3 is provided to help you resolve system defects. Each FPS-5 system consists of the following components:

- ▷ Transducer sensor cable
- ▷ Signal processor main circuit board
- ▷ Individual zone processor circuit boards (Two on each main circuit card)
- ▷ Transponder circuit board
- ▷ Relay circuit board

Table 4 provides voltage measurements inside the FPS processor. In addition to the FPS-5 system, you should consult the technical information on the alarm control and display system for additional troubleshooting procedures.

Troubleshooting the system can be accomplished by systematically checking the entire system to isolate the causes of the problem. The following procedures have been prepared to isolate the problem to one of the three integral parts of the system which will allow replacement of the faulty component. These procedures are not intended to allow repair of a faulty component, other than the repair of a faulty transducer sensor cable which can be accomplished at the installation site.

Troubleshooting to the board level can be accomplished with a common high impedance volt/ohm meter or digital voltmeter.

NOTE: DO NOT USE A LOW IMPEDANCE VOLT/OHM METER AS INCORRECT READINGS WILL BE OBTAINED.

Repair

Perform system repairs using good commercial practice. It is recommended that repairs be performed by personnel who have received factory training. Improper repairs or system damage caused by untrained personnel can affect the warranty.

Isolate defective components by swapping field connections with known good components or by using spare components reserved for maintenance actions. Repairs to equipment and circuits contained in the alarm processor are not recommended.

Return components thought to be defective to Magal-Senstar for repair in accordance with the repair procedure. Include information describing the nature of the problem with the returned component. This will shorten factory repair time.